

AM1018B – Amplifier

20 MHz to 6 GHz Gain Block

Description

AM1018B is a high dynamic range cascadable gain block covering the 20 MHz to 6 GHz frequency range. It operates from a +5.0VDC supply and exhibits a flat frequency response and high third order intercept performance while also providing excellent gain stability over the operating temperature range. With internal 50Ω matching and packaged in a 3mm QFN or a shielded module, the AM1018B represents a compact total PCB footprint.

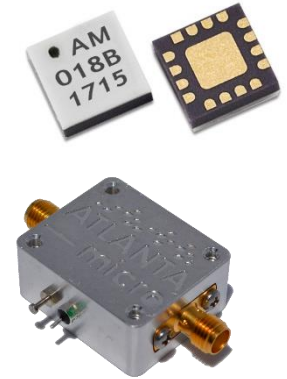

Features

- 13 dB Gain
- 3.0 dB Noise Figure
- +35 dBm OIP3
- +22 dBm P1dB
- +5.0V, 115 mA
- 3mm QFN Package
- -40C to +85C Operation
- Unconditionally Stable

Functional Diagram

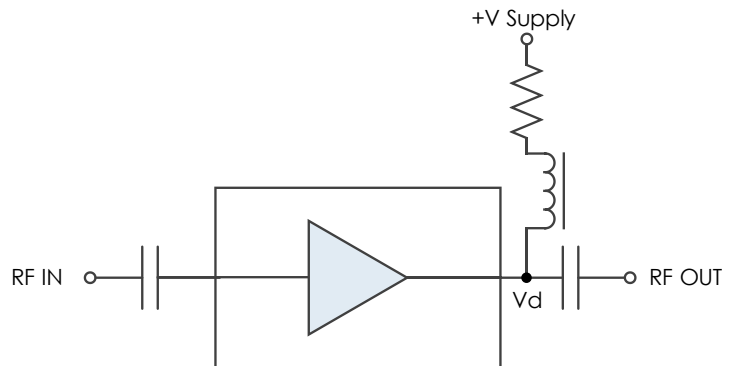

Characteristic Performance

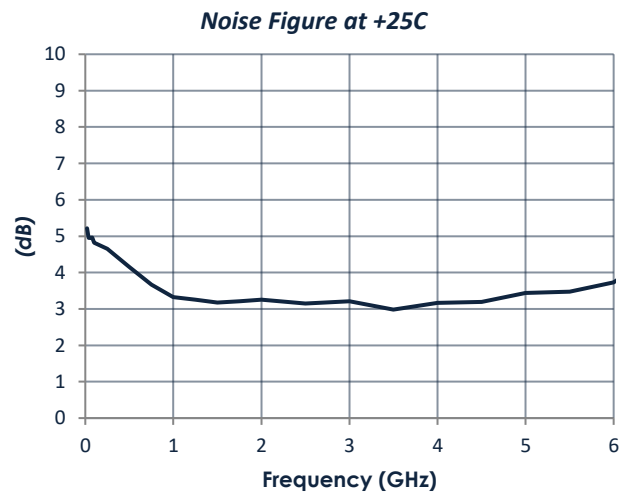
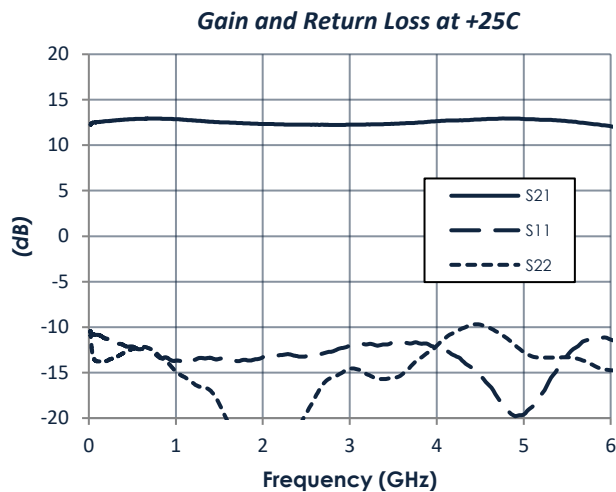

Table of Contents

Description	1	Thermal Information	4
Features	1	DC Electrical Characteristics	5
Functional Diagram	1	RF Performance	5
Characteristic Performance	1	Typical Performance	6
Revision History	2	Typical Application	8
Pin Layout and Definitions	3	Part Ordering Details	9
Specifications	4	Related Parts	9
Absolute Maximum Ratings	4	Evaluation Board	9
Handling Information	4	Component Compliance Information	10
Recommended Operating Conditions	4		

Revision History

Date	Revision Number	Notes
August 28, 2017	1	Initial Release
September 11, 2017	2	Figures Updated
April 17, 2019	3	Updated to Latest Datasheet Format. Noise Figure Corrected.
August 2, 2019	4	Min/Typ/Max Current Values Changed. RF-Shielded Module Information Added.
November 26, 2019	4A	Updated Description to include shielded module packaging
May 15, 2020	5	Package and module information moved to main product page

Pin Layout and Definitions

NOTE: All Non-Named Pins Are NC or GND

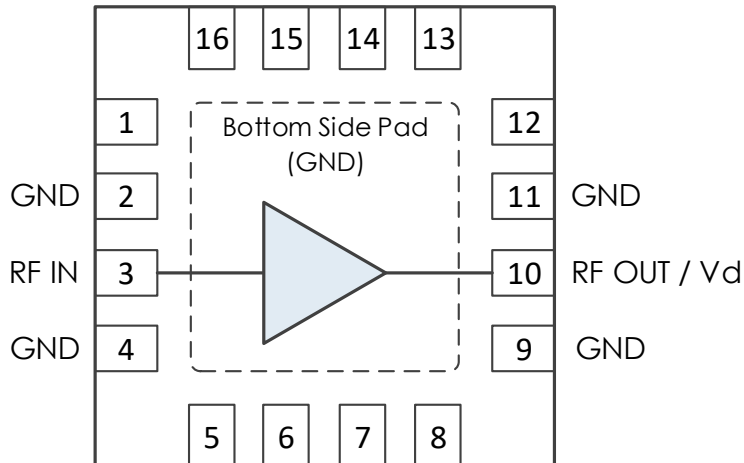

Pin Number	Pin Name	Pin Function
1	NC	Not Connected*
2	GND	Ground – Common
3	RF IN	RF Input – 50 ohms – DC Coupled, External DC Block Required
4	GND	Ground - Common
5 - 8	NC	Not Connected*
9	GND	Ground – Common
10	RF OUT / Vd	RF Output and DC Power Input – 50 ohms – DC Coupled, External DC Block Required
11	GND	Ground - Common
12 - 16	NC	Not Connected*
Bottom Pad	GND	Ground – Common

*Note: NC pins may be grounded or left open.

AM1018B – Amplifier

20 MHz to 6 GHz Gain Block



Specifications

Absolute Maximum Ratings

	Minimum	Maximum
Device Voltage, Vd	0.0 V	+4.2 V
RF Input Power		+20 dBm
Operating Junction Temperature	-40 C	+150 C
Storage Temperature Range	-50 C	+150 C

Note: Any device operation beyond the Absolute Maximum Ratings may result in permanent damage to the device. The values listed in this table are extremes and do not imply functional operation of the device at these or any other conditions beyond what is listed under Recommended Operating Conditions. Any part subjected to conditions outside of what is recommended for an extended amount of time may suffer from reliability concerns.

Handling Information

	Minimum	Maximum
Storage Temperature Range (Recommended)	-50 C	+125 C
Moisture Sensitivity Level	MSL 3	



Atlanta Micro products are electrostatic sensitive.
Follow safe handling practices to avoid damage

Recommended Operating Conditions

	Minimum	Typical	Maximum
Supply Voltage, Vsupply	+4.7 V	+5.0 V	+5.2V
Device Voltage, Vd	+3.5 V	+3.8 V	+4.0 V
Operating Case Temperature	-40 C	+25 C	+85 C
Operating Junction Temperature	-40 C		+125 C

Thermal Information

	Thermal Resistance (°C / W)
Junction to Case Thermal Resistance (θ_{JC})	76.33

AM1018B – Amplifier

20 MHz to 6 GHz Gain Block

DC Electrical Characteristics

(T = 25 °C unless otherwise specified)

Parameter	Testing Conditions	Minimum	Typical	Maximum
Device Voltage, Vd	Vsupply = +5.0 V	+3.5V	+3.8 V	+4.0V
DC Supply Current	Vsupply = +5.0 V	105 mA	115 mA	125 mA
Power Dissipated	Vsupply = +5.0 V	0.40 W	0.46 W	0.50 W

RF Performance

(T = 25 °C unless otherwise specified)

Parameter	Testing Conditions	Minimum	Typical	Maximum
Frequency Range		20 MHz		6 GHz
Gain	f = 3 GHz		13 dB	
Output IP3	f = 3 GHz		+35 dB	
Output P1dB	f = 3 GHz		+22 dB	
Noise Figure	f = 3 GHz		3.0 dB	

AM1018B – Amplifier

20 MHz to 6 GHz Gain Block

Typical Performance

(Vd = +3.8V, ID=115mA)

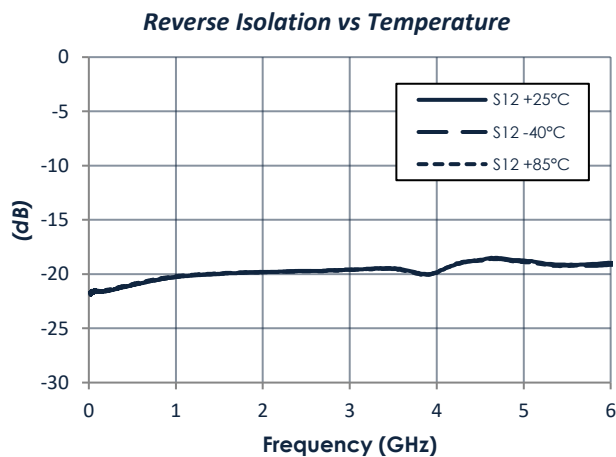
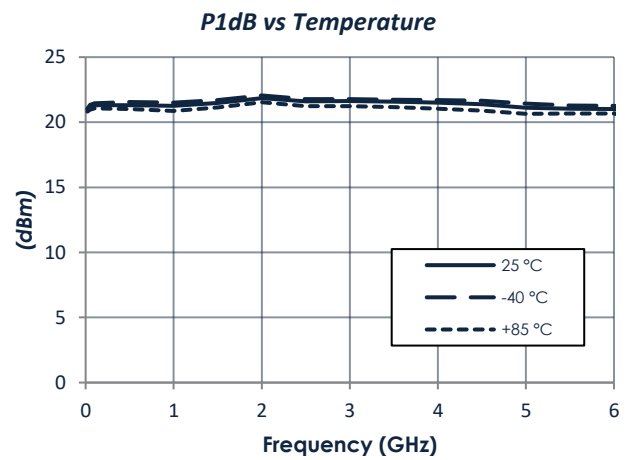
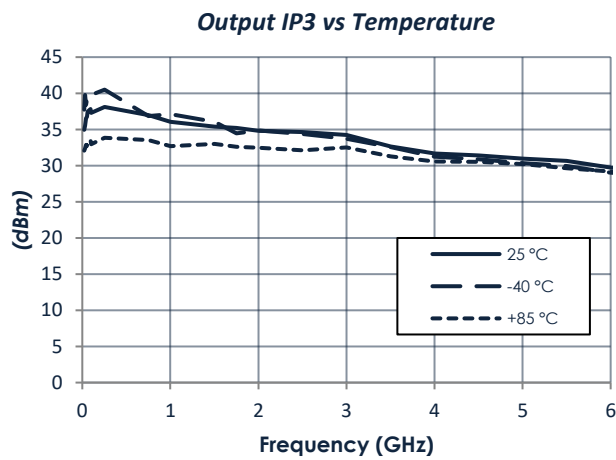
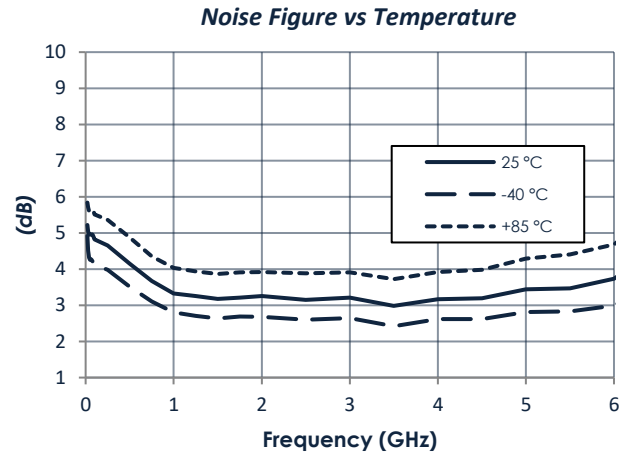
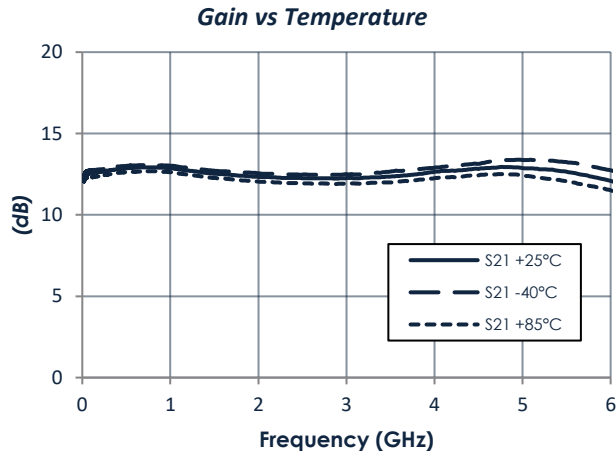

AM1018B – Amplifier

20 MHz to 6 GHz Gain Block

Typical Performance (continued)

(Vd = +3.8V, ID=115mA)

Power Saturation at +25C

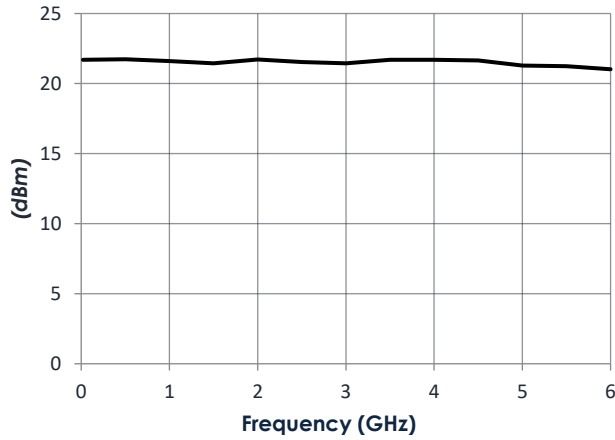

Pin vs. Pout at +25C

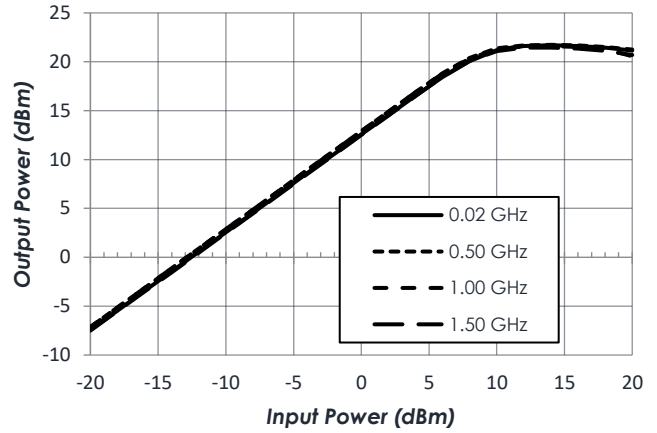

Pin vs. Pout at +25C

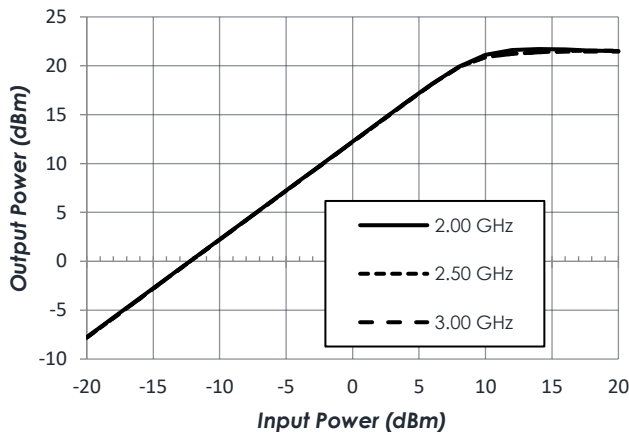

Pin vs. Pout at +25C

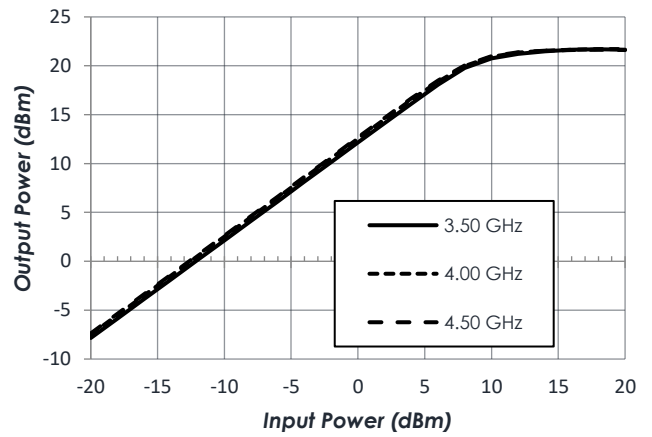

Pin vs. Pout at +25C

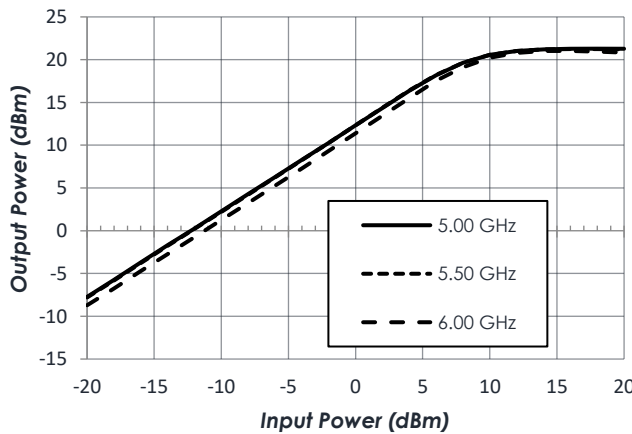

Typical Application

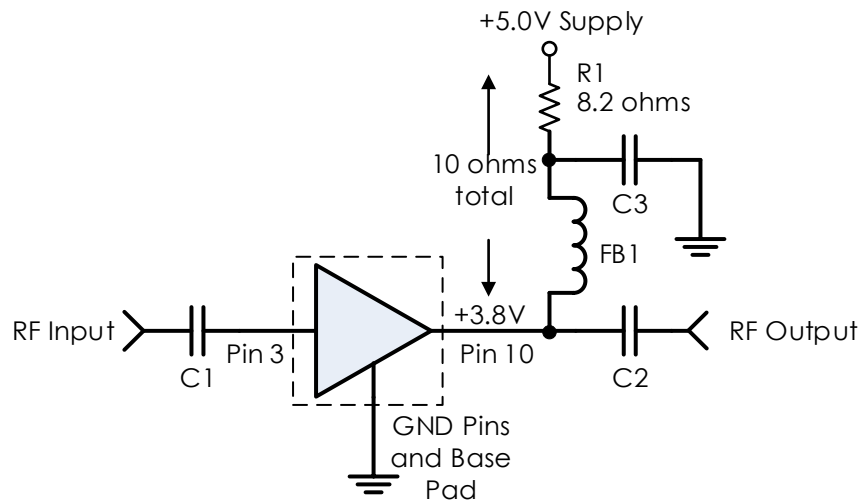

Recommended Component List (or equivalent):

Part	Value	Part Number	Manufacturer
C1, C2	0.1 μ F	0402BB104KW160	Passives Plus
C3	0.1 μ F	GRM155R71C104KA88	Murata
FB1	-	MMZ1005A222E	TDK
R1	8.2 ohms	RL0510S-8R2-F	Susumu (1/6 W)

Notes:

1. Dropping resistor R1 is required.
2. NC pins may be grounded or left open.
3. DC blocking capacitors should be high performance, low-loss, broadband capacitors for optimum performance.

AM1018B – Amplifier

20 MHz to 6 GHz Gain Block



Part Ordering Details

Description	Part Number
3mm 16 Lead QFN	AM1018B
AM1018B Evaluation Board	AM1018B Eval
AM1018B in 0.95" x 1.13" x 0.6" RF-Shielded Module with Integrated Bias Tee and Field Replaceable SMA Connectors	AM1018B-M

Related Parts

Part Number	Description
AM1016B	20 MHz to 6 GHz +3.3V Gain Block
AM1018A	20 MHz to 6 GHz +3.3V Gain Block
AM1018C	20 MHz to 6 GHz +5.0V Gain Block
AM1025B	20 MHz to 3 GHz +8.0V Gain Block (High P1dB)
AM1031C	20 MHz to 8 GHz +3.3V Gain Block
AM1063-1	DC to 10 GHz Gain Block
AM1064-1	DC to 8 GHz Gain Block
AM1085	DC to 6 GHz +5.0V Gain Block
AM1090	DC to 6 GHz +5.0V or +8.0V Gain Block

Evaluation Board

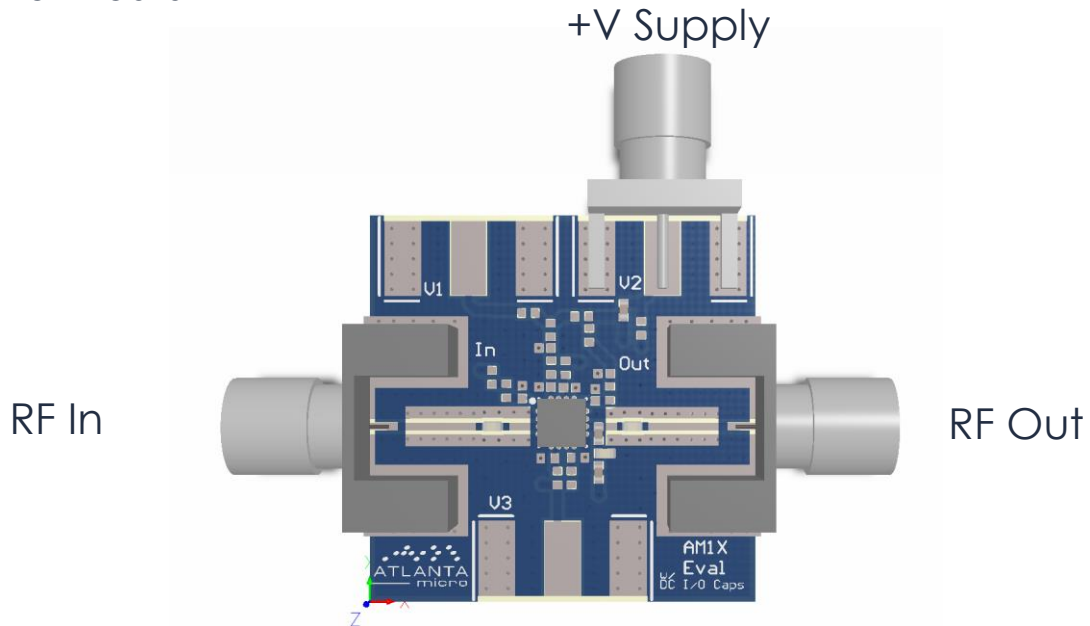

To obtain price, delivery, or to place an order contact sales@atlantamicro.com
 Atlanta Micro Inc., 3720 Davinci Ct, Suite 125, Peachtree Corners, GA 30092 • Phone: (470) 253-7640 • www.atlantamicro.com

Component Compliance Information

RoHS: Atlanta Micro, Inc. hereby certifies that all products comply with the EC Directive 2011/65/EC on the Restriction of Hazardous Substances, commonly known as EU-RoHS 6 and 10. All products supplied by Atlanta Micro shall be compliant with the European Directive 2011/65/EC based on the following substance list.

Substance List	Allowable Maximum Concentration
Lead (Pb)	<1000 PPM (0.1% by weight)
Mercury (Hg)	<1000 PPM (0.1% by weight)
Cadmium (Cd)	<75 PPM (0.0075% by weight)
Hexavalent Chromium (CrVI)	<1000 PPM (0.1% by weight)
Polybrominated Biphenyls (PBB)	<1000 PPM (0.1% by weight)
Polybrominated Diphenyl ethers (PBDE)	<1000 PPM (0.1% by weight)
Decabromodiphenyl Deca BDE	<1000 PPM (0.1% by weight)
Bis (2-ethylhexyl) Phthalate (DEHP)	<1000 PPM (0.1% by weight)
Butyl Benzyl Phthalate (BBP)	<1000 PPM (0.1% by weight)
Dibutyl Phthalate (DBP)	<1000 PPM (0.1% by weight)
Diisobutyl Phthalate (DIBP)	<1000 PPM (0.1% by weight)

REACH: Atlanta Micro, Inc. neither uses nor intentionally adds any of the substances considered to be a Substance of Very High Concern (SVHC) as defined by the EU Regulation (EC) No. 1907-2006 on Registration, Evaluation, Authorization, and Restriction of Chemicals (REACH).

Conflict Materials: Atlanta Micro does not knowingly use materials that are sourced from the Democratic Republic of Congo (DRC) or any other known conflict regions. Atlanta Micro's supply chain is comprised of sources that are both environmentally and socially responsible. We periodically review this requirement with our vendors to ensure continued compliance.

Atlanta Micro takes its responsibility as a global partner seriously and will use due diligence within our supply chain to ensure all standards are met to the best of our knowledge.