

RES HD 3U Rugged Chassis

20" Deep, Rear I/O and Front I/O Rugged Blade Chassis

- Extended 15 year lifespan
- 6 slots for "plug and pull" blades
- Blade backward and forward compatibility
- Redundant AC/DC power for high availability
- Portable with rugged transit case
- MIL-STD 810G



Technical Specifications

Reliability

Safety: EN60950
RFI/EMI: EN 55032, EN 55024, EN 61000
MIL-STD 810G

Environmental*

Operating

Temperature: 0°C to 50°C
Humidity: 8% to 95%
Shock: 3 axis, 35g, 25ms
Vibration (10-2000Hz): 4.76Grms, 5Hz to 2000 Hz (SSD)

Non-Operating (if different)

Temperature: -40°C to 70°C
Humidity: 5% to 95%

Power Supply Options

Single or Redundant 100/240V VAC (1200W, 50/60Hz, 400Hz)
Single or Redundant 10-36 VDC, 32 Amps
Single or Redundant 36-72 VDC, 18 Amps

Additional Options

Shock Pins
Front Door Filter
Slide Rails

Mechanical

Height: 5.25 inches (133.35mm)
Width: 17 inches (432mm)
Depth: 20 inches (508mm)
Weight: ~24.5lbs (11.1kg)
19" rackmountable

*Mercury Systems designs all products to meet or exceed listed data sheet specifications. Some specifications including I/O profiles, weight, and thermal profiles are configuration dependent. Contact Mercury for information specific to your desired configuration requirements.

Accessories

18-30" Slide Rail and Shock Pin Kit
Rugged Transit Case
Height: 12 inches, Length: 34 inches, Width: 24 inches
Material: Polycarbonate
Features: Detachable front/rear lids, handles and wheels

Six Chassis Slots with Redundant Power

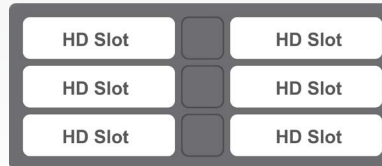

Configure Your Way

Compute-Optimized

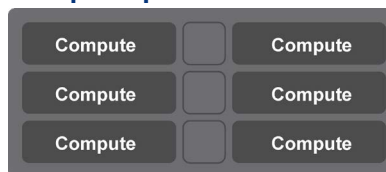

Mixed



Balanced

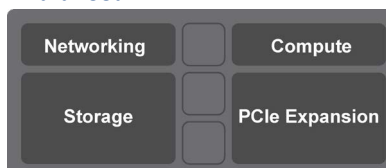

Custom Expertise

For tailor-made systems with specific security and environmental requirements, email servers@mrcy.com

FRONT INPUT/OUTPUT

Front View

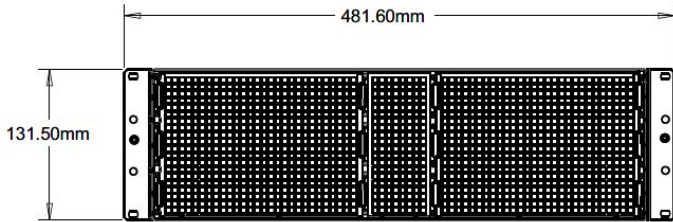

Side View

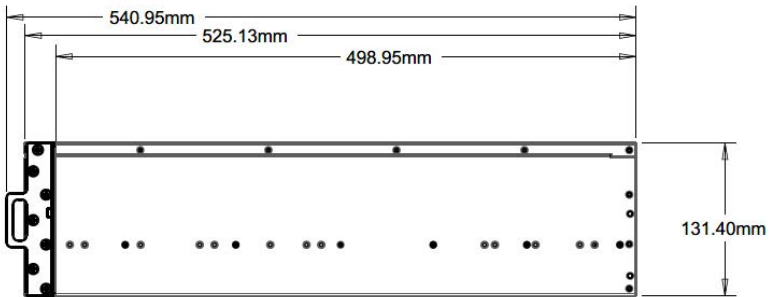

Top View

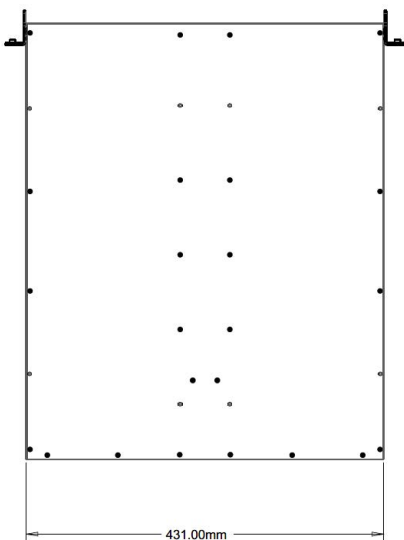

REAR INPUT/OUTPUT

Front View

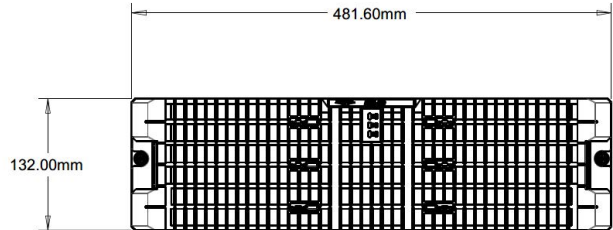

Side View

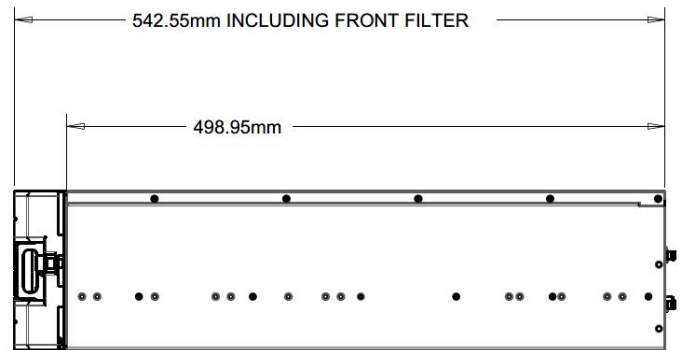

Top View

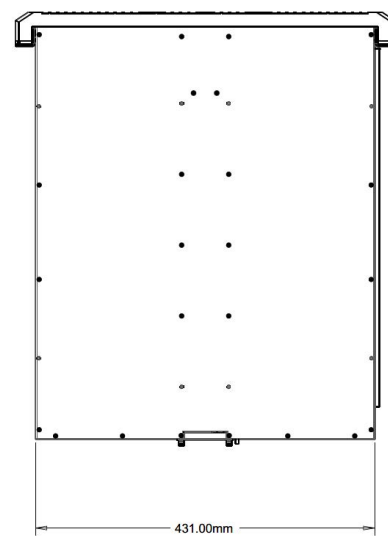

Innovation That Matters, and Mercury Systems are trademarks of Mercury Systems, Inc. Other product and company names mentioned may be trademarks and/or registered trademarks of their respective holders. Mercury Systems, Inc. believes this information is accurate as of its publication date and is not responsible for any inadvertent errors. The information contained herein is subject to change without notice.

Copyright © 2020 Mercury Systems, Inc.

6586.00E-0820-DS-RESHD3UChassis



INNOVATION THAT MATTERS[®]

MERCURY SYSTEMS

50 Minuteman Road • Andover, MA 01810 USA
(978) 967-1401 • Fax (978) 967-3330

MERCURY SYSTEMS INTERNATIONAL

Regus Center, 26 Avenue Jean Kuntzmann
Montbonnot • 38330 France
+33 608 419949