

## RF, Microwave and Mixed-Signal Solutions

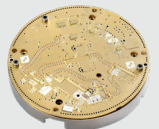
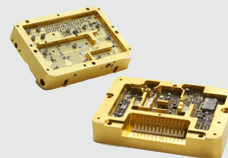
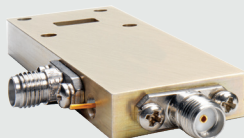

# RF, Microwave and Mixed-Signal Solutions from Mercury Systems

Mercury Systems is an established leader in the design and manufacture of RF components and sub-assemblies for defense and aerospace applications. Our technical competencies include open-architecture solutions, densely-integrated microwave modules, compact GaN-based amplifiers and direct digitization technology.

## Innovation That Matters

At its core, Mercury Systems is a technology company. Leveraging significant investments in R&D and a deep industry understanding, we develop innovative technology to address the most relevant challenges. Our advanced packaging and integration capabilities give us the edge in ultra-compact RF microelectronics. Through leadership in OpenVPX™ and a modular design approach, we continue to push the industry forward.

## Automated and Trusted Manufacturing

To enable a rapid transition from engineering to production, Mercury invests in the latest automated manufacturing technology. Our four Advanced Microelectronic Centers (AMCs), located in Phoenix, AZ; Hudson, NH; West Caldwell, NJ; and Huntsville, AL include capabilities such as automated die attach, auto-bonders and automated SMT assembly.

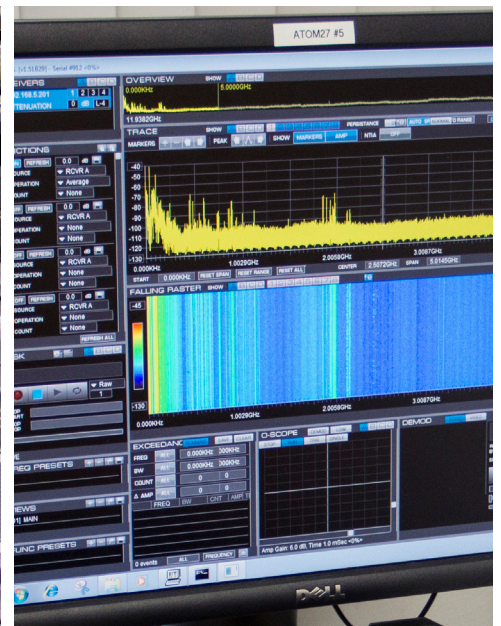
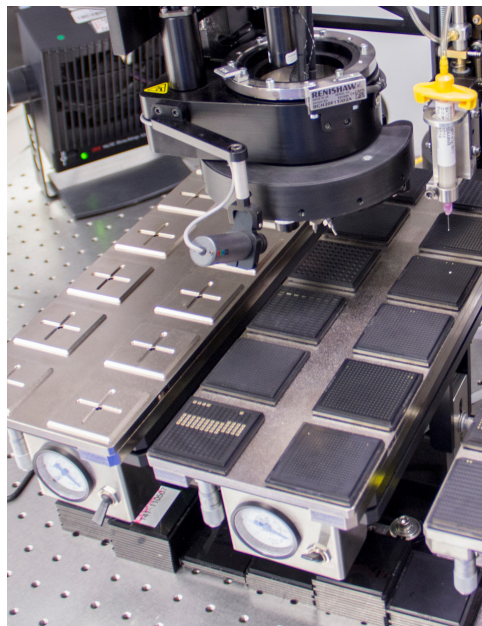

	<b>Integrated Microwave Assemblies</b> .....	<b>4</b>		<b>Filters</b> .....	<b>14</b>
	Custom Frequency-Conversion Subassemblies			Low-Pass	
	Integrated Switch Matrices			High-Pass	
	Digital Instantaneous Frequency Measurement Receivers			Band-Pass	
	Integrated RF and Digital Architecture			Band-Rejection	
	Synthesizers and Signal Generators			Diplexers	
	Custom Solutions			GPS Diplexers	
	Multiplexers				
	<b>Frequency Converters and Transceivers</b> .....	<b>6</b>		<b>GPS Filter/Amplifiers</b> .....	<b>16</b>
	Open-Architecture Microwave Transceivers			<b>Ferrites</b> .....	<b>17</b>
	High-Performance Microwave Converters			Coaxial Circulators	
	IF-to-IF Converters			Drop-in Circulators	
	<b>Open Architecture, Mixed-Signal Solution</b> .....	<b>7</b>		Surface-Mount Circulators	
	Digital IF Transceivers			Coaxial Isolators	
	Clock Generation and Distribution Modules			Drop-in Isolators	
	Coherent, OpenVPX Systems			Surface-Mount Isolators	
	<b>Space-Qualified Products</b> .....	<b>8</b>		<b>Mixers</b> .....	<b>20</b>
	SSPAs			<b>Multipliers</b> .....	<b>20</b>
	Mixers			<b>Voltage Controlled Oscillators</b> .....	<b>21</b>
	Ferrites			<b>High-Power Surface-Mount Limiters</b> .....	<b>21</b>
	VCOs			<b>Noise Products</b> .....	<b>22</b>
	Filters			Broadband, Coaxial	
	Filter/Amplifiers			Fullband, Coaxial	
	<b>Amplifiers</b> .....	<b>10</b>		Surface-Mount	
	High-Power, Broadband, CW			High-Power	
	High-Power, Narrowband, CW			<b>Switches</b> .....	<b>23</b>
	High-Power, Pulsed			High-Speed	
	High-Power, Rackmount			High-Power SPDT	
	Low-Noise			Low-Power	
	Medium-Power, Broadband				
	Ultra-Low Phase Noise				
	Millimeter Wave				
				<b>Trusted Manufacturing Capabilities</b> .....	<b>24</b>

Specifications and availability are subject to change without notice

## Custom Frequency-Conversion Subassemblies

- Frequency coverage 10MHz to 110GHz
- Super-heterodyne, image/LO reject, and sub-harmonic topologies
- Automatic Gain Control (AGC) and Built-In-Test (BIT)
- Embedded micro-controller capability

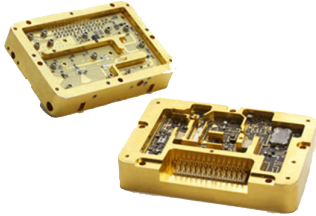

At Mercury Systems we are specialists in the design and manufacture of custom integrated microwave assemblies (IMAs)—including high-performance microwave transceivers. Through substantial R&D investment and a library of building blocks, we have the capability to rapidly execute on the most complicated of transceiver designs. As an OpenVPX industry leader, we know how to make integration into your system a breeze.

### Frequency Converter Product Families:

- Block Up-Converters (BUC): Custom products available by integrating a Mercury up-converter with a Mercury SSPA
- Low Noise Blocks (LNB): Custom products available by integrating a Mercury down-converter with a Mercury LNA
- Transceivers: Custom designs by combining up/down converters with additional components such as PLL and digital control

## Integrated Switch Matrices

Our family of rugged, custom-designed switch matrices are available in rigid PCB construction, module-based packages or rack-mount solutions. Each switch matrix is a highly integrated, SWaP-optimized assembly consisting of an assortment of switches, filters, amplifiers, attenuators, limiters and drivers. The result is high speed channel selection, high isolation, high linearity and low insertion loss.

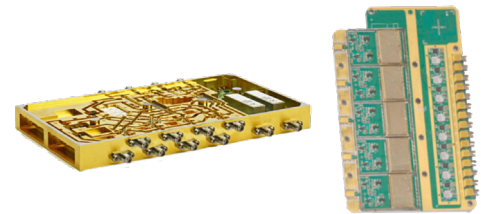

- From 10MHz to 40GHz
- Include position indicating, BIT circuitry, input/output power detection, switched attenuators, & on-board PC power conditioning

## Digital Instantaneous Frequency Measurement (DIFM) Receivers

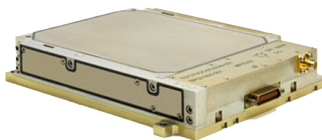

- Frequencies up to 18GHz
- Digital word output format
- TTL or ECL digital interface
- Rated for airborne operation from -40°C to +85°C

We offer a range of standard high-performance broadband Digital Instantaneous Frequency Measurement (DIFM) receivers and Digital Frequency Discrimination (DFD), which act as functional building blocks in many military electronic warfare systems. Examples include electronic counter measures (ECM) systems, electronic surveillance measures (ESM) systems and radar warning receivers (RWR).

Model Number	Operating Freq.	Freq. Resolution	Input Dynamic Range	Digital Freq. Word
FM020511	2.5 – 5.0 GHz	1.45 MHz	-13 to +10dBm	11 bit
FM021814	2.0 – 18.0 GHz	1.0 MHz	-50 to + 10dBm	14 bit

## Integrated RF and Digital Architecture

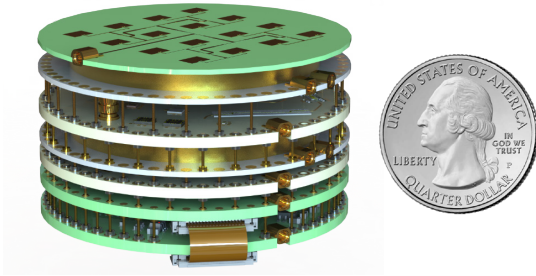

The modular nature of the SpectrumSeries platform enables rapid scaling and can easily be customized to support a variety of applications. For low-complexity designs, few layers are needed. As the complexity grows, additional layers are added to increase the functionality. To provide maximum flexibility, each layer can be individually customized to meet specific customer requirements.

The SpectrumSeries™ Compact Multi-Band Platform is a complete sensor chain solution in development to address the need for low-cost, high-performance, small-size hardware that has the reliability for the most demanding environments.

Ideal for sub-50 mm self-guided munitions, digital beam forming and UAV payloads, this modular technology can integrate an RF front-end with a digital module in a ruggedized package with diameter smaller than one inch.

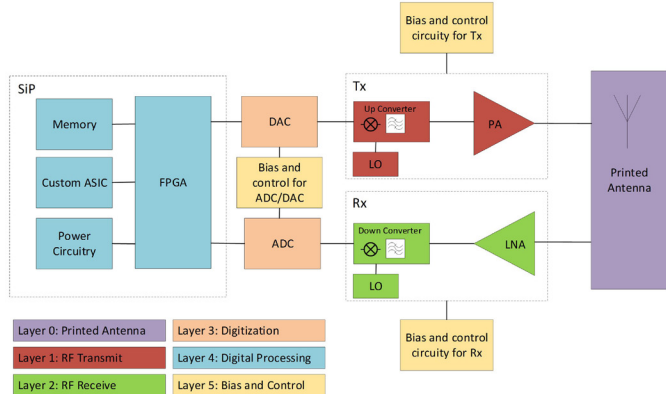

## Synthesizers and Signal Generators



- Frequencies up to 20 GHz
- State-of-the-Art Phase Noise
- Auto-Sensing Reference
- Multiple form factors available

Our comprehensive line of microwave synthesizers and signal generators are available in a variety of form factors and provide industry-leading performance. The off-the-shelf products feature a modular design to enable rapid customization to specific customer needs.

Model	Description	Tuning Bandwidth	Phase Noise @ 10kHz offset	Form Factor
DS-1500	Synthesizer	2GHz BW in 8-16 GHz range	<-121 dBc/Hz @10GHz	Compact Module
DS-3000	Multi-octave Synthesizer	0.1 to 20 GHz, 1Hz steps	<-121 dBc/Hz @10GHz	Module
SiG-20	Microwave Signal Generator	0.1 to 20 GHz, 1Hz steps	<-121 dBc/Hz @10GHz	Bench Top

## Custom IMA Solutions

- Frequencies to 110GHz
- SWaP-Optimized building blocks
- Advanced non-linear device modeling
- RF and digital integration
- Technology & process agnostic
- SMT and bare die manufacturing

When you need a custom RF/Microwave solution for your critical application, Mercury Systems is the supplier of choice. With extensive investments in R&D, a world class engineering team and a wide breadth of competencies; we are uniquely positioned to take on the toughest technical challenges. When the competitors cut R&D funding, we invest heavily to develop cutting edge capability in SWaP-optimized, high performing products.

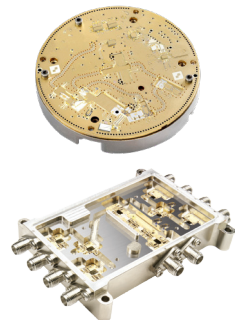

## Open-Architecture Microwave Transceivers



Our microwave OpenVPX™ and VME transceivers provide cutting edge performance in convenient 3U and 6U form factors and are optimized to seamlessly integrate with our line of digital IF transceivers. From electronic warfare to beam steering, these ruggedized microwave modules are equipped to support your toughest application.

Model Number	Description	Channels	RF (GHz)	IF (GHz)	Gain (dB)	Noise Figure (dB)	IP3 (dBm)	Tuning Speed (µs)	Format/size
RFM3101	Wideband transceiver	1 up / 1 down	6 – 18	1.375 – 2.375	20	14 dB (typical)	30 (up convert OIP3)	25	3U OpenVPX OpenRFM
RFM3102	Wideband tuner	2 down	6 – 18	1.375 – 2.375	20	14 dB (typical)	30 (OIP3)	25	3U OpenVPX OpenRFM
RFM1802 with ADV1800 Synthesizer	Wideband tuner	2 down	0.5 – 18	Narrow Band: 0.12 - 0.20 Wide Band: 0.75 - 1.25	22	13 dB (typical)	0 (IIP3)	3	6U VME

## High-Performance Microwave Converters



- Frequencies up to 40 GHz
- Instantaneous bandwidth up to 2 GHz
- Agile, tunable IF available
- Ethernet control interfaces

Our standard microwave converter products offer RF performance up to 40GHz with a 2GHz IBW. The modular design approach enables rapid customization and is optimized for demanding SIGINT/ELINT applications.

Model	Description	Max Frequency	Max IBW	Tuning Speed	Form Factor
RFT-3100	Fixed IF Downconverter	40 GHz	2 GHz	600 µs	Rackmount
RFT-3100-C	Dual Channel, Phase Coherent Downconverter	40 GHz	2 GHz	600 µs	Rackmount
RFT-3200	Agile IF Downconverter	40 GHz	2 GHz	600 µs	Rackmount
RFT-3300	Rugged Downconverter	40 GHz	2 GHz	600 µs	Half ATR
RFT-4100	Fixed IF Upconverter	40 GHz	2 GHz	600 µs	Rackmount
RFT-4200	Agile IF Upconverter	40 GHz	2 GHz	600 µs	Rackmount
RFT 5100	Up/Down Converter w/ shared LO	40 GHz	2 GHz	600 µs	Rackmount

## IF-to-IF Converters



- IF frequencies up to 8 GHz
- Up and down conversion
- Available in rackmount or benchtop

Are you limited by your IF? Our IF-to-IF converter products have been created to solve the limitation caused by fixed, static, IF's. Whether it's a signal recorder, digitizer, signal analyzer or waveform generator, our products can transform your IF from what have to what you need.

Model	Input Frequency Range	Output Frequency Range	Selectable BW
IFAT-2000	50 MHz to 2000 MHz	50 MHz to 2000 MHz	5 BWs, 50 to 1000 MHz
IFAT-2200	10 MHz to 2000 MHz	10 MHz to 2000 MHz	8 BWs, 10 to 1000 MHz
IFAT-2400	1 MHz to 2000 MHz	1 MHz to 2000 MHz	13 BWs, 0.1 to 1000 MHz
IFAT-8000	50 MHz to 8 GHz	50 MHz to 8 GHz	5 BWs, 50 to 1000 MHz
IFAT-8400	1 MHz to 8 GHz	1 MHz to 8 GHz	13 BWs, 0.1 to 1000 MHz

## Digital IF Transceivers

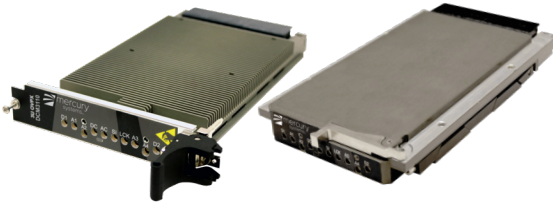

Our EnsembleSeries™ IF processing and direct conversion solutions enable the real-time digitization and processing of complex signals. We integrate the most advanced ADC, DAC and FPGA technology in 3U and 6U OpenVPX™ modules to create a product portfolio to support applications such as electronic warfare, spectrum monitoring and digital beam steering.

Model Number	Processor	Memory	ADC Channels	DAC Channels	Format/size
DCM3110	Kintex® Ultrascale™ KU115 FPGA	4GB DDR4	2 12-bit, 3.0 GSPS	2 12-bit, 3.0 GSPS	3U OpenVPX (VITA 65)
DCM6111	3 Kintex® Ultrascale™ KU115 FPGAs	18GB DDR4	2 12-bit, 2.5 GSPS	2 12-bit, 3.0 GSPS	6U OpenVPX (VITA 65)
DCM6112	3 Kintex® Ultrascale™ KU115 FPGAs	16GB DDR4	4 12-bit, 3.2 GSPS	4 12-bit, 3.2 GSPS	6U OpenVPX (VITA 65)
DCM6212	3 Kintex® Ultrascale™ KU115 FPGAs	16GB DDR4	2 12-bit, 6.4 GSPS	2 12-bit, 6.4 GSPS	6U OpenVPX (VITA 65)

## Clock Generation and Distribution Modules



Our clock technology incorporates a modular design approach to enable rapid factory customization. This flexible architecture also includes multiple coherent outputs in a convenient OpenVPX form factor. Ideal for applications such as direction finding and digital beam forming that require multiple coherent clock channels all operating with minimal jitter, this modular clock technology provides the high-fidelity performance for next-generation systems.

Model Number	Description	Freq. Max	Number of banks	Outputs per bank	Format / Size
CLK3002	Coherent Clock Module	4 GHz	3	6	3U OpenVPX

## Coherent, OpenVPX Systems

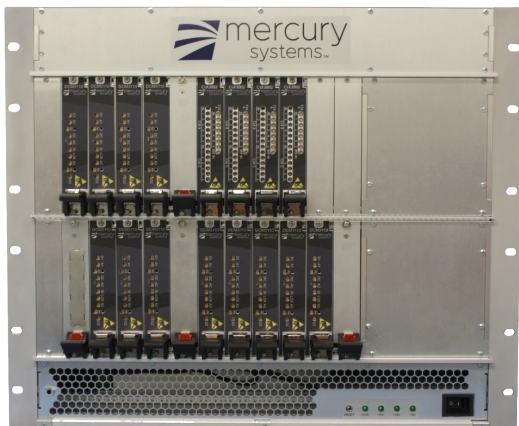

Through the adoption of open architectures, such as OpenVPX™, we provide rapid integration of multiple RF, mixed-signal, and processing modules into high-performance, coherent systems. In order to reduce cost and lead time, these systems consist primarily of our catalog OpenVPX products as well as third-party COTs hardware as needed. For programs with specific environmental or electrical needs, customized transceiver and processing modules are available.

### Capability Highlights:

- Multiple, coherent channels
- Direct digitization
- Microwave frequency conversion
- Real-time FPGA processing
- OpenVPX flexibility

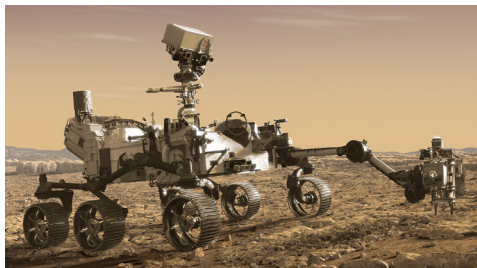

Here at Mercury Systems we proudly stand behind our four decades of leadership delivering cutting-edge, space-qualified hardware to defense primes, government agencies and commercial customers. Engineered to the most stringent performance standards, we have delivered more than 20,000 space-qualified products with no in-flight failures.

During the last 20 years, every mission to Mars has included Mercury's space-qualified technology.

### Solid-State Power Amplifiers

Model Number	Freq. Range (GHz)	Gain (dB)	Output Power P3dB (dBm) typ
DM-HPS-8-102-S	2.2 - 2.3	44	39 dBm (8W)
DM-HPS-50-102-S	2.2 - 2.3	50	47 dBm (50W)
DM-HPX-5-103-S	7.25 - 7.75	40	37dBm (5W)
DM-HPX-10-103-S	7.25 - 7.75	40	40 dBm (10W)
DM-HPX-20-103-S	7.25 - 7.75	45	43 dBm (20W)
DM-HPX-4-102-S	7.9 - 8.4	40	36 dBm (4W)
DM-HPX-8-102-S	7.9 - 8.4	40	39 dBm (8W)
DM-HPX-15-102-S	7.9 - 8.4	45	42 dBm (15W)

### Space-Qualified Mixers

Freq. Range (GHz)	Type	LO Power (dBm) typ.	Conversion Loss (dB) typ./max	IF Frequency (GHz)	LO to RF Isolation (dBm) min/typ.	LO to IF Isolation (dBm) min/typ.	IP3 IN typ.	P1dB IN typ.
2-8	Double Balanced	10-19	7/9	0.01-4	16/25	17/28	13	4
2-12	Double Balanced	7 to 16	7/8.5	DC-1.5	18/38	18/35	11 to 19	1 to 10
2-18	Double Balanced	7 to 16	7.3/8.5	DC-2	22/27	15/22	11	1
2-18	Double Balanced	10-19	6.8/8.5	1.5-8	16/28	16/28	16	7
5-18	Double Balanced	7 to 16	6.2/8	DC-4	22/35	20/30	11 to 19	1 to 10
2-8	Triple Balanced	10 to 19	6.2/9	0.01-4	16/26	21/28	14 to 21	4 to 13
3-6	IQ Mixers	10 to 17	5.5/8.5	DC-0.5	25/31	25/31	17	8
5.6-9	IQ Mixers	10 to 17	5/7	DC-0.5	25/31	25/31	17	8
8-13	IQ Mixers	10 to 17	5/7	DC-0.5	25/31	25/31	17	8

### Space-Qualified Ferrites

Model Number	Freq. Range (GHz)	Type	Isolation dB (min)	Insertion Loss dB (max)	VSWR	Dimensions (inches)
DNF2540-T0045	.980 - 1.000	Drop-in Isolator	17	1	1.43:1	1.00 X 1.00 X .30
DNF1900T0160F	1.80 - 1.95	Drop-in Isolator	18	0.6	1.30:1	0.750 X 0.750 X 0.25
DNF1900T0248FM	2.1 - 2.2	Drop-in Isolator	20	0.4	1.25:1	0.750 X 0.750 X 0.250
DNF1900T0266F	2.2 - 2.3	Drop-in Isolator	20	0.4	1.25:1	0.750 X 0.750 X 0.250
DNF2222T0201	2.0 - 4.0	Drop-in Isolator	15	0.8	1.45:1	0.875 X 0.875 X 0.345
DNF2667F0401	4.0 - 6.0	Microstrip Launch Isolator	18	0.9	1.40:1	1.05 X 0.75 X 0.28
T008M02	8.38 - 8.46	Coaxial Isolator w/flange SMA	20	0.3	1.25:1	0.625 X 1.00 X 0.375
T-008D02	7.90 - 8.50	Coaxial Isolator	20	0.4	1.25:1	0.375 X 0.380 X 0.210
SMF635F0813-F	8.0 - 9.0	Drop-in Isolator	18	0.6	1.30:1	0.25 X 0.50 X 0.18
T606S26	6.0 - 12.0	Coaxial Isolator	16	0.7	1.35:1	1.35 X 1.15 X .5
DNF2032F1001	10.0 - 14.0	Microstrip Launch Isolator	15	1.1	1.50:1	0.80 X 0.54 X 0.28
T412S27	12.0 - 18.0	Coaxial Isolator	18	0.5	1.30:1	0.69 X 0.95 X 0.50
DNF2032F1201	12.0 - 18.0	Microstrip Launch Isolator	15	1.1	1.40:1	0.80 X 0.54 X 0.28
SMF635F1708	17.3 - 18.5	Drop-in Isolator	18	0.5	1.30:1	0.25 X 0.50 X 0.18
T018S06	18.5 - 18.9	Coaxial Isolator	20	0.5	1.22:1	0.500 X 0.500 X 0.630



### Space-Qualified VCOs

Frequency (MHz)	Tuning Voltage (V)	Power Output (dBm)	Harmonic Suppression (max)
800 – 1600	0.5/5 V	6 +/-3	-8
1600 - 3200	0.5/18 V	7 +/-2	-15
2000 – 4000	0.5/20 V	3 +/-3	-18
4000 – 6000	0.5/20 V	4 +/-4	-25

### Space-Qualified Filters

Model Number	Passband (MHz)	Type	Insertion Loss (dB)	Rejection
L1355	1575.42	GPS Bandpass Filter	0.25	30dBc at 1200MHz, 60dBc at 2100MHz
S2306	2200 - 2300	Band Reject Filter	0.4	30 dB from 2000 - 2045 MHz
S1974	2260 - 2500 & 2360 - 2600	Ultra Linear Bandpass Filter	3	30 dB from 1980-2220MHz, 30dB from 2080-2320MHz
C1970	6468 - 6588	Ultra Linear Bandpass Filter	3	61 dBc at F0 ± 207MHz
C1814	6836 - 7016	Ultra Linear Bandpass Filter	1.7	65 dBc at F0 ± 395MHz
Ku1960	17300 - 17700	Ku Band Bandpass Filter	1	40dB at 17800MHz
E1911	19700 - 20200	Ka Band Bandpass Filter	2	35dB at 19500MHz, 50dB at 30000MHz
E1507	29510 - 29746	Ka Band Bandpass Filter	1.5	40dB at 29510MHz, 40dB at 30112MHz
E1508	29754 - 29990	Ka Band Bandpass Filter	1.5	40dB at 29388MHz, 40dB at 30356MHz











### Space-Qualified GPS Filter/Amplifiers (L1, L2, L5)

Model Number	L2 (1227 MHz) Bandwidth	L1 (1575 MHz) Bandwidth	Gain (dB)	Noise Figure (dB)	Connectors
L5699-1S	+/- 10 MHz	+/- 10 MHz	30	3.0	SMA
L56102	+/- 10 MHz	+/- 10 MHz	40	2.5	SMA
L56113	L2 & L5	+/- 10 MHz	40	2.5	SMA
L5475-1	NA	+/- 10 MHz	22	2.5	SMA
L5988	NA	+/- 10 MHz	10	3.0	SMA

### Space-Qualified Telemetry Filter/Amplifiers

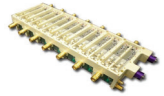
Model Number	Passband (MHz)	Gain (dB)	Noise Figure (dB)	Connectors
S59109	2025 to 2060	45 +/- 3	2.5	SMA
S59128	2025 to 2100	45 +/- 3	2.5	SMA
S59111	2200 to 2400	37.5 +/- 2.5	1.5	SMA

### Custom Space-Qualified Components

<p><b>Broadband High-Isolation SP3T</b></p> 	<p><b>High-Power Gain and Phase Matched Assembly with Switches and AGC</b></p> 	<p><b>Space Directional Coupler High-Power</b></p> 
<p><b>Display Diplexer / Amplifier/ combiner</b></p> 	<p><b>Hybrids</b></p> 	<p><b>Splitters Space-Qualified</b></p> 
<p><b>X16 Frequency Multiplier</b></p> 	<p><b>Ku band Diplexer / Switch / Coupler / Amplifier</b></p> 	<p><b>Switch / Filter / Amplifier with Integrated Cooling and Noise Diodes</b></p> 
<p><b>Gain Equalizer</b></p> 	<p><b>Space-Qualified Ku band Filter / Amplifier</b></p> 	<p><b>Solid-State Power Amplifier</b></p> 

## High-Power, Broadband, CW Amplifiers



Our high-power, broadband, CW amplifiers are ideal for electronic warfare applications. These compact products offer high output power through technologies such as GaN devices and novel power combing structures. Available in rugged, hermetic packages, these amplifiers are optimized for operation in harsh environments.

Model Number	Freq. Range (GHz)	Psat (dBm)	Psat (W) typ.	Gain (dB)	PAE, typ.	Voltage (V), Current (A)
DM-HPMB-10-103	0.1 - 6.0	39	10	55	20%	28V, 2.2A
DM-HPMB-25-102	0.5 - 6.0	43	25	50	20%	50V, 2.3A
DM-HPMS-25-101	1.0 - 3.0	43	25	50	30%	45V, 2.5A
DM-HPMS-100-101	1.0 - 3.0	49	100	50	25%	45V, 10A
DM-HPSC-25-101	2.0 - 6.0	43	25	45	30%	28V, 3A
DM-HPSC-80-101	2.0 - 6.0	48	80	50	25%	28V, 12A
DM-HPSC-150-101	2.0 - 6.0	51	150	60	25%	28V, 25A
DM-HPMB-5-101	2.0 - 18.0	36	5	45	15%	32V, 1.5A
AML218P4011	2.0 - 18.0	39	10	40	12%	32V, 2.3A
AML218P4013	2.0 - 18.0	42	20	38	12%	32V, 4.9A
AML618P4014	6.0 - 18.0	40	10	40	12%	32V, 2.8A
DM-HPMB-25-101	6.0 - 18.0	40	15	50	15%	28V, 4.5A
AML618P4015	6.0 - 18.0	42	15	40	12%	32V, 4.9A
L0618-46	6.0 - 18.0	46	40	40	7%	12V, 12A
L0618-50-T523	6.0 - 18.0	50	100	50	8%	35V, 35A
L1826-36	18.0 - 26.0	36	4	38	5%	12V, 8A
L1840-27	18.0 - 40.0	26	0.45	30	3%	12V, 4A

## High-Power, Narrowband, CW Amplifiers

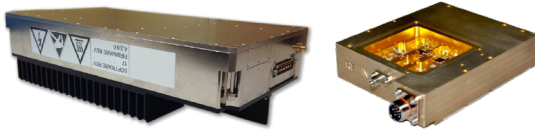

Our high-power, narrowband, CW amplifiers are ideal for rugged communication applications. These high-performance products utilize GaAs and GaN devices to maximize linearity and output power all in compact form factors. With reliability built in from the earliest design phases, these power amplifiers can be trusted to perform in the harshest environments.

Model Number	Freq. Range (GHz)	Psat (dBm)	Psat (W) typ.	Gain (dB)	PAE, typ.	Voltage (V), Current (A)
DM-HPS-35-101	2.2 - 2.5	45.5	35	20	35%	28V, 3.6A
MSC56P5050	5.0 - 6.0	48	63	50	30%	30V, 11A
DM-HPC-60-101	5.5 - 8.5	46	50	50	25%	28V, 6.5A
AML811P5012	7.8 - 11.0	45.5	35	50	23%	28V, 5.5A
AML811P5013	7.8 - 11.0	48	63	50	25%	28V, 11.5A
DM-HPX-25-101	8.0 - 11.0	43	25	45	30%	28V, 3.5A
DM-HPX-30-101	8.0 - 11.0	44	30	45	22%	28V, 5.5A
DM-HPX-50-102	8.0 - 11.0	46	50	50	30%	28V, 6.0A
L0812-46	8.0 - 12.0	46	40	45	12%	12V, 28A
DM-HPX-100-105	9.75 - 10.25	49.5	100	50	30%	28V, 17A
DM-HPKU-25-105	13.75 - 14.5	44	25	45	20%	24V, 6A
DM-HPKU-40-105	13.75 - 14.5	47	50	45	25%	24V, 10A
AML1416P4512	14.0 - 16.0	44	25	45	18%	35V, 6.2A
DM-HPKU-40-101	14.4 - 15.5	44	30	45	15%	28V, 6.5A
L2426-40	24.0 - 26.0	39.5	9	40	5%	12V, 16A
L2632-37	26.0 - 32.0	37	5	38	5%	12V, 10A
DM-HPKA-10-102	29.0 - 31.0	40	10	50	15%	20V, 3.6A
DM-HPKA-20-102	29.0 - 31.0	42	20	50	15%	20V, 6A
L3236-38	32.0 - 36.0	38	6.3	40	5%	12V, 17A
L3434-40	34.0 - 34.5	40	10	45	5%	12V, 17A
L3640-37	36.0 - 40.0	37.5	5.6	40	5%	12V, 17A

## High-Power Pulsed Amplifiers



To support advanced radar applications, we have developed a line of high-power, narrowband, pulsed amplifiers. Using GaN device technology, power levels in excess 1 kW at frequencies above 10GHz are available. For custom systems, we leverage our proven building-block design approach to rapidly deliver a solid-state power amplifier for your program.

Model Number	Freq. Range (GHz)	Psat (dBm)	Psat (W) typ.	Gain (dB)	PAE, typ.	Voltage (V)
DM-HPL-1K-101	1.2 - 1.4	59	1000	60	42%	65V
DM-HPL-1K-102	1.2 - 1.4	61	1600	60	40%	50V
DM-HPS-1K-105	2.7 - 2.9	60.5	1250	60	35%	32V
DM-HPS-800-102	2.9 - 3.1	58.5	800	60	40%	32V
DM-HPS-1K-103	2.9 - 3.1	61	1300	60	35%	32V
DM-HPS-1K-103	3.1 - 3.5	58.5	800	60	40%	50V
DM-HPS-1K-104	3.1 - 3.5	61	1300	60	35%	50V
DM-HPC-50-105	5.2 - 5.9	46	50	50	35%	32V
AML59P4513	5.5 - 9.0	46	50	45	20%	28V
DM-HPX-140-101	7.8 - 9.6	51	140	50	30%	40V
DM-HPX-250-102	9.4 - 10.1	53	250	50	30%	50V
DM-HPX-1K-101	9.4 - 10.1	61.5	1500	60	25%	50V
AML910P4215	9.9 - 10.7	42	20	46	25%	32V
MSC167P7046	16.0 - 17.0	45	46	70	20%	30V

## High-Power, Rackmount Amplifiers



Our RF rackmount amplifiers utilize advanced power combining techniques to achieve high output power. These integrated amplifiers include cooling capabilities and are ready for easy installation into a larger system.

Model Number	Freq. Range (GHz)	Psat (dBm)	Psat (W) typ.	P1dB (dBm)	Pac (kW)	Height (in)
C033036-51	3.3 - 3.6	51	125	50	1	8.75
C059064-55	5.9 - 6.4	55	300	52	3	10.25
C0618-43	6.0 - 18.0	43	20	41.5	0.3	5.25
C0618-46	6.0 - 18.0	46	40	44.5	0.75	8.75
C0812-46	8.0 - 12.0	46	40	44	0.4	5.25
C090105-50	9.0 - 10.5	50	100	49	1	8.75

## Low-Noise Amplifiers

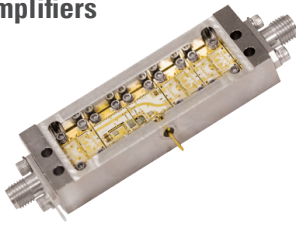

Broadband, narrowband, high frequency. Our extensive portfolio of LNAs is ready to tackle the toughest requirements. Don't see exactly what you need? We have a vast library of building blocks ready to support any custom design.

### Low-Noise Amplifiers, Broadband

Model Number	Freq. Range (GHz)	Gain (dB)	Flatness (±dB)	NF (dB)	P1dB (dBm)	OIP3 (dBm) typ.	VSWR (In/Out) typ.	Voltage (V), Current (mA)
AML016L2814	0.1 - 6.0	28	1.25	1.3*	7	14	2.0:1	12V, 190mA
AML0118L2512	0.1 - 18.0	25	1.5	2.5*	6	16	2.0:1	12V, 160mA
DM-LNMB-13-101	0.1 - 26.5	13	2	5.5*	15	23	2.2:1	12V, 200mA
AML18L3001	1.0 - 8.0	30	2	1.8	13	22	1.8:1	12V, 110mA
AML240L2201	2.0 - 40.0	22	3	6	15	25	2.0:1	12V, 350mA
AML48L3002	4.0 - 8.0	30	1	1	10	20	1.8:1	12V, 100mA
AML618L4011	6.0 - 18.0	40	2	1.6	10	20	2.0:1	12V, 220mA
AML812L3003	8.0 - 12.0	30	1.5	1.3	10	18	2.0:1	12V, 150mA
DM-LNK-30-101	18 - 26.5	28	2	3.5	8	15	2.0:1	12V, 140mA

\*above 500 MHz

### Low-Noise Amplifiers, Narrowband

Model Number	Freq. Range (GHz)	Gain (dB)	Flatness (±dB)	NF (dB)	P1dB (dBm)	OIP3 (dBm) typ.	VSWR (In/Out) typ.	Voltage (V), Current (mA)
AML33L3201	3.1 - 3.6	32	1	0.6	18	28	1.8:1	12V, 150mA
AML45L2802	4.4 - 5.0	28	1	0.7	10	18	2.01:1	12V, 100mA
DM-LNC-30-101	4.4 - 6.0	28	1	1	10	18	2.0:1	12V, 200mA
AML56L2802	5.9 - 6.4	28	1	0.7	10	18	2.0:1	12V, 100mA
DM-LNX-45-102	7.2 - 8.4	45	1	1.1	10	20	1.5:1	12V, 150mA
DM-LNX-45-101	9.5 - 10.5	45	1	1.1	10	20	1.4:1	12V, 190mA
DM-LNX-28-102-WG	10.2 - 10.45	28	1	1.25	10	20	1.5:1	12V, 150mA
DM-LNKU-28-102-WG	14.4 - 14.8	26	1	1.5	10	23	1.5:1	12V, 150mA
DM-LNK-40-101	19.2 - 21.2	40	1.5	1.4	15	22	2.0:1	12V, 190mA
DM-LNKA-60-101	24.0 - 30.0	58	1.5	3	8	15	2.0:1	12V, 200mA

## Medium-Power, Broadband Amplifiers



Our medium power, broadband amplifiers utilize advanced design techniques to achieve solid performance in gain, flatness, noise figure and output power over an extremely wide frequency range.

Model Number	Freq. Range (GHz)	Gain (dB)	Flatness (±dB)	NF (dB)	P1dB (dBm)	OIP3 (dBm) typ.	VSWR (In/Out) typ.	Voltage (V), Current (mA)
AML0118P3201	0.1 - 18.0	32	3	3.5*	26*	32*	2.5:1	15V, 750mA
AML0126P3002	0.1 - 26.5	30	3	6.0*	22	30	2.0:1	12V, 600mA
DM-MPMB-20-101	0.5 - 18.0	20	1.75	6.5	23	31	2.0:1	11V, 450mA
AML118P2703	1.0 - 18.0	27	2	4	27	34	2.0:1	15V, 525mA
AML120P3201	1.0 - 20.0	32	3.5	5	27	32	2.0:1	15V, 1500mA
DM-MPSC-18-102	2.0 - 6.5	16	1	5.6	24	34	1.8:1	11V, 475mA
DM-MPMB-18-101	2.0 - 18.0	18	1.25	5.6	24	32	2.0:1	11V, 500mA
DM-MPMB-25-102	6.0 - 18.0	25	2	3	20	30	2.0:1	11V, 450mA
AML618P4202	6.0 - 18.0	42	2.5	3	35	42	1.8:1	12V, 2200mA
AML1840P2802	18.0 - 40.0	35	3	6.5	22	28	2.0:1	12V, 800mA

\*above 500 MHz

## Ultra-Low Phase Noise Amplifiers

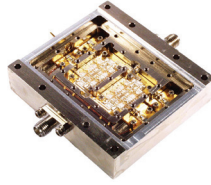

When phase noise is critical, turn to our line of low phase noise amplifiers. Taking full advantage of the industry's best device technology, these parts are designed to meet the toughest requirements.

Model Number	Freq. Range (GHz)	Gain (dB) min	Flatness (±dB) max	Phase Noise					NF (dB) max	P1dB (dBm) min	VSWR (In/Out) nom	Voltage (V), Current (mA)
				100Hz	1KHz	10KHz	100KHz	1MHz				
AML083PNA1801	0.8 - 3.0	18	1	-150	-160	-166	-170	-173	5	17	2.5:1	12V,100mA
AML26PNA1001	2.0 - 6.0	10.5	1	-150	-160	-168	-174	-175	6	16.5	1.5:1	8V,115mA
AML26PNC1511	2.0 - 6.0	15	2	-145	-155	-160	-165	-170	7	34	1.5:1	12V,2700mA
AML218PNA3213	2 - 18	32	2.5	-125	-140	-145	-155	-160	4	25	2.0:1	12V,500mA
AML69PNA1601	6.0 - 9.0	16	1	-140	-150	-155	-160	-165	6.5	23	1.8:1	12V,450mA
AML69PNC1511	6.0 - 9.0	14	1	-145	-155	-160	-165	-170	8	34	1.4:1	12V,2300mA
AML612PNA1411	6.0 - 12.0	14	1	-143	-150	-155	-160	-167	6	25	2.0:1	12V,500mA
AML812PNB1813	8.0 - 12.0	18	2	-150	-160	-168	-172	-175	7	17	1.5:1	12V,250mA
AML812PNA0803	8.0 - 12.0	8	1.5	-145	-153	-160	-165	-168	6	25	1.8:1	12V,250mA
AML1518PNA1711	15.0 - 18.0	14	0.5	-135	-145	-155	-163	-167	6	26	1.8:1	12V,500mA
AML4040PNB1511	40.0	15	2	-135	-146	-150	-155	-160	-	24	2.0:1	6V,1200mA

## Millimeter-Wave Amplifiers

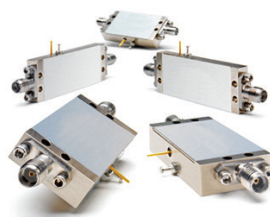

When your application requires operating at Ka-band and above, trust our millimeter wave amplifiers to perform. With standard designs up to 65GHz and custom products available, We are ready to support your high-frequency requirement.

Model Number	Freq. Range (GHz)	Gain (dB)min	Flatness (±dB) max	P1dB (dBm) min	Noise Figure (dB) max	VSWR (In/Out) nom	DC Current (mA)
MSC1840L3001	18.0 - 40.0	30	2	10	4.5	2.25:1	350
MSC1840L3201	18.0 - 40.0	32	2.5	15	5.5	2.2:1	440
MSC2640L3701	26.0 - 40.0	37	2	10	3	2.25:1	275
MSC4060L3001	40.0 - 60.0	30	3	10	8.5	3.0:1	300
MSC6065L2001	60.0 - 65.0	20	1.5	10	8.5	3.0:1	250



At Mercury Systems we offer a wide range of compact, low loss, high Q filters utilizing advanced lumped element and cavity technologies. With experience manufacturing space-qualified hardware, we have developed the capability to have reliability built-in from the first design phase. With state-of-the-art modeling software and an on-site machine shop, we are uniquely positioned deliver a standard product or custom designed filter.

### Low-Pass Filters

Model Number	Passband Start (MHz)	Passband Stop (MHz)	Loss (dB)	Size (inches)	Connectors
S3905	1	3300	0.5	0.5 x 0.5 x 2.0	SMA Female
U3510	1	125	0.5	1.0 x 2.0 x 8.0	"N" Female
U3929	1	50	0.7	1.0 x 1.0 x 7.0	SMA Female
U3930	1	300	0.5	1.0 x 1.0 x 3.0	SMA Female
X3906	1	8000	1	0.5 x 0.9 x 5.0	SMA Female
C3705	1	7000	0.5	0.25" di x 1.5" long	SMA Female
C3903	1	4400	1	0.5" di x 2.75" long	SMA Female
L3706	40	2500	0.2	0.75 x 0.75 x 2.5	SMA Female
U3931	405	460	0.3	1.5 x 1.5 x 8.0	"N" Female
S3906	1900	3050	0.25	0.5 x 0.5 x 3.5	SMA Female
S3917	1900	3050	0.25	0.5 x 0.5 x 3.5	"N" Female
S3910	2200	2300	0.15	0.5 x 0.5 x 1.85	SMA Female
Ku3905	14400	17300	0.25	1.3" x 1.3" x 2.5"	WR-62 Flange

### High-Pass Filters

Model Number	Passband Start (MHz)	Passband Stop (MHz)	Loss (dB)	Size (inches)	Connectors
U7905	30	1000	1	0.7 x 1.0 x 1.25	SMA Female
U7702	100	2000	0.25	1.0 x 2.0 x 8.0	"N" Female
E7101	18000	22000	1	0.4 x 0.6 x 4.0	"K" Female

### Band-Pass Filters

Model Number	Passband Start (MHz)	Passband Stop (MHz)	Loss (dB)	Size (inches)	Connectors
L1953	0.1	910	0.3	1.5 x 1.63 x 14	APC 7mm
U1974	30	88	1	1.0 x 1.75 x 5.5	N Female
U1920	60	250	0.6	1.25 x 1.5 x 7.5	SMA Female
U1920-2	100	180	0.6	1.25 x 1.5 x 7.5	SMA Female
U1450	100	100	3	0.5 x 0.5 x 1.0	SMT
U1657	130	400	0.65	0.75 x 1.0 x 2.5	SMA Female
U1213	148	150	3	0.5 x 1.0 x 1.0	SMA Female
U1393	174	174	1	1.5 x 7.0 x 0.4	SMT
U1460	200	200	2.5	TO-8	SMT
U1969	216	408	1.5	0.9 x 1.75 x 5.5	SMA Female
U1499	935	960	0.5	8.0 x 2.5 x 2.0	N Female
L1318	1535	1585	0.3	1.0 x 2.0 x 3.0	SMA Female
L1427	1574.4	1574.4	1.6	0.55 x 1.45 x 2.0	SMA Female
S1579	2040	2080	1	1.0 x 1.5 x 2.4	SMA Female
S1628	2500	2540	0.75	1.5 x 2.6 x 3.7	SMA Female
C1322	6000	8000	1	1.5 x 1.0 x 1.5	SMA Female
Ku1954	13000	15500	1	0.62 x 0.62 x 3.2	SMA Female
Ku1953	18500	20500	1	0.62 x 0.62 x 2.25	SMA Female
E1506	19700	20200	1.5	0.624 x 0.625 x 3.0	K Female
E1508	29754	29990	1.5	0.5 x 0.5 x 2.5	K Female

**Band-Rejection Filters**

Model Number	Reject-band Start (MHz)	Reject-band Stop (MHz)	Rejection (dB)	Size (inches)	Connectors
U2506	0.1	668	30	0.5 x 1.4 x 2.9	SMA Female
U2514	88	108	20	0.5 x 1.2 x 1.2	SMA Female
U2501	518	526	55	2.0 x 2.5 x 7.5	SMA Female
L2514	1227	1227	60	1.5 x 2.0 x 7.0	SMA Female
L2911	1534	1616	35	1.5 x 1.5 x 10.75	SMA Female
L2516	1565	1585	40	1.5 x 2.0 x 7.0	SMA Female
L2511	1602	1620	35	1.5 x 1.5 x 7.0	N Female
L2509	1626.5	1660	45	1.25 x 1.5 x 10	N Female
L2908	1700	1800	80	1.5 x 1.5 x 14	N Female
S2907	3700	3625	20	1.25 x 1.25 x 11.25	SMA Female
X2504	4000	6500	40	0.75 x 1.5 x 4.0	SMA Female
C2707	4250	4350	40	0.75 x 1.2 x 2.5	TNC Female
S2501	5400	5920	80	1.0 x 1.0 x 6.0	N Female
X2601	6300	8700	40	0.75 x 1.5 x 4.0	SMA Female
C2801	6900	7100	60	0.63 x 1.0 x 3.7	SMA Female
X2503	9400	9500	30	0.75 x 1.5 x 4.0	SMA Female
X2308	13400	14000	15	0.5 x 1.0 x 2.0	SMA Female

**Diplexers**

Model Number	Low Passband Start (MHz)	Low Passband Stop (MHz)	High Passband Start (MHz)	High Passband Stop (MHz)	Insertion Loss (dB)	Size (inches)	Connectors
U5920	30	88	116	400	0.5	1.8 x 3.2 x 5.5	TNC
U5994	118	137	225	400	0.5	1.0 x 2.0 x 4.0	"N" Female
L5969	140	400	950	1600	0.4	1.0 x 3.0 x 3.8	"N" Female
L5938	225	400	950	1600	0.4	1.0 x 3.0 x 3.75	"N" Female
U5620	824	835	869	880	0.7	3.0 x 4.5 x 14.2	"N" Female
L5634	1027	1033	1084	1095	0.5	1.5 x 2.75 x 4.0	SMA Female
L5748	1215	1240	1520	1585	0.75	1.5 x 2.5 x 7.5	SMA Female
S5401	1435	1540	2200	2300	0.3	1.6 x 3.1 x 3.7	SMA Female
L5624	1525	1545	1646.5	1646.5	1	1.5 x 3.5 x 8.0	SMA Female
L5680	1535	1543	1636.5	1645	0.55	1.5 x 5.1 x 7.0	N Female
L5617	1552	1556	1653	1657	1	1.0 x 6.0 x 12.0	N Female
L5692	1552	1556	1653	1657	1	3.0 x 6.0 x 12.0	TNC Female
S5717	1750	1850	2200	2300	0.5	1.5 x 2.5 x 7.5	SMA Female
C5938	2500	4000	4000	7500	1	1.0 x 1.5 x 2.1	N Female
C5914	3700	4200	5925	6430	1	0.75 x 3.0 x 3.0	N Female
C5515	5735	5735	5800	5800	0.5	0.75 x 2.5 x 3.0	SMA Female
X5908	6000	7200	9900	10300	1.5	0.8 x 1.5 x 4.4	SMA Female
X5510	8175	8225	8475	8525	2	0.5 x 1.0 x 2.0	SMA Female
Ku5606	14400	14830	15150	15350	1.5	0.4 x 1.4 x 2.1	SMA Female

## GPS Diplexers

Model Number	L2 (1227 MHz) Bandwidth	L1 (1575 MHz) Bandwidth	Insertion Loss (dB)	Size (inches)	Connectors
L5513	+/-8	+/-8	0.45	2.1 x 4.0 x 9.8	SMA Female
L5745	+/-8	+/-8	0.75	1.5 x 2.5 x 7.5	SMA Female
L5647	+/-10	+/-10	0.8	1.3 x 2.5 x 7.5	SMA Female
L54144	+/-12	+/-12	0.5	1.0 x 3.0 x 3.0	SMA Female
L5215	+/-15	+/-15	1.5	0.5 x 1.34 x 1.38	SMA Female

## Multiplexers

Model Number	Passband 1 (MHz)	Passband 2 (MHz)	Passband 3 (MHz)	Passband 4 (MHz)	Insertion Loss (dB)	Size (inches)	Connectors
U5988	138-174	450-512	824-904	1850-1990	1	2.25 x 3.0 x 5.0	"N" Female
S5452	1435-1540	1750-1850	2200-2290	2310-2400	0.5	2.0 x 3.7 x 8.0	SMA Female
S5424	1544-1555	1670-1710	2020-2040	2200-2300	0.5	1.5 x 6.0 x 8.0	"N" Female
U5995	880-915	925-960	1710-1785	1805-1880	1.1	3.5 x 3.8 x 10.0	SMA Female
U5997	880-915	925-960	1710-1785	1805-1880	1.1	3.5 x 3.8 x 10.0	SMA Female

## GPS Filter/Amplifiers

Our GPS filters/amplifiers is the right choice for your high reliability GPS receiver. Whether your application is ground, airborne or missile, you can trust our technology behind these advanced products. Custom designs including multiple outputs and receiver protection limiters are also available.

Model Number	L2 (1227 MHz) Bandwidth	L1 (1575 MHz) Bandwidth	Gain (dB)	Noise Figure (dB)	Size (inches)	Connectors
L54108	NA	+/- 8	25	2.5	0.5 x 1.0 x 2.0	SMA Female
L54138	NA	+/- 10	25	2.9	0.84 x 1.5 x 4.5	SMA Female
L5217	NA	+/- 10	20	2	0.6 x 1.81 x 3.0	SMA Female
L54129	+/- 1	+/- 8	25	1.5	1.5 x 3.0 x 3.0	SMA Female
L54112	+/-8	+/-8	40	2.5	0.63 x 3.5 x 4.0	SMA Female
L5676	+/- 10	+/- 10	25	2	0.5 x 2.2 x 4.0	SMA Female
L54113	+/- 10	+/- 10	25	2.5	0.5 x 2.2 x 2.75	SMA Female
L5697	+/-10	+/-10	34	3	0.5 x 3.0 x 3.0	SMA Female
L5698	+/-10	+/-10	30	3.6	0.85 x 2.5 x 4.0	TNC Female
L59105	+/- 12	+/- 12	23	2.5	1.75 x 2.5 x 9.0	SMA Female
L59103	+/-15	+/-15	48	2	2.0 x 5.75 x 9.0	SMA Female
L59106	+/- 18	+/- 18	24	3	1.6 x 2.72 x 8.44	SMA Female



At Mercury Systems our well-established product family of isolators and circulators has a proven track record of successes on the ground, in the air and in space. The standard products with frequencies from 150MHz to 40GHz and bandwidths from 5% to multi-octave are complemented by the technical capabilities to address the most challenging custom requirements.

The newly updated SMT family of ferrites has been refined to give the best performance in your size and weight constrained systems.

### Coaxial Circulators

Model Number	Freq. Range (GHz)	Isolation dB	Insertion Loss	VSWR	Power (Watts) (peak/avg)
C1000N01	0.6 - 1.8	25	2.4	1.60:1	250 / 375

### Drop-in Circulators

Model Number	Freq. Range (GHz)	Isolation dB	Insertion Loss	VSWR	Power (Watts) (peak/avg)
DNF1300C0618	6.0 - 18.0	13	0.4	1.60:1	1
SMF950C0902	9.0 - 10.0	20	0.5	1.25:1	50 / 16.5
SMF635C1601	16.1 - 16.5	20	0.7	1.25:1	10

### Surface-Mount Circulators

Model Number	Freq. Range (GHz)	Isolation dB	Insertion Loss	VSWR	Power (Watts) (peak/avg)
SMD1900C3134	3.1 - 3.4	25	0.3	1.12:1	100 / 30
SMD1300C0401	4.0 - 5.0	15	0.5	1.25:1	10
SMD1300C0503	5.0 - 6.0	20	0.5	1.25:1	5
SMD1300C0601	6.5 - 7.5	20	0.5	1.25:1	5
SMD1300C0800	8.0 - 12.0	20	0.5	1.25:1	125 / 3.2

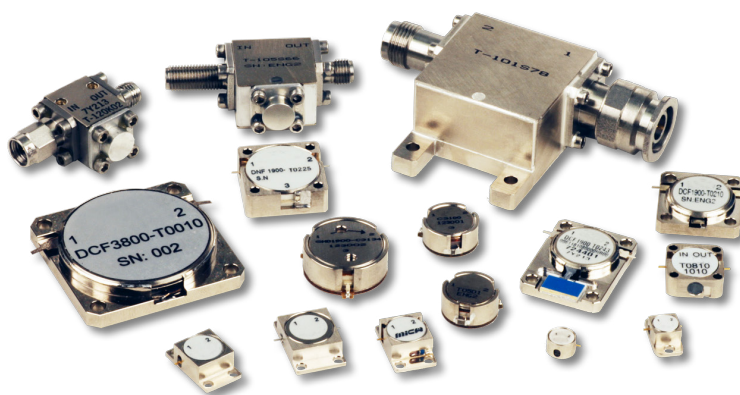

## Coaxial Isolators

Model Number	Freq. Range (GHz)	Isolation dB	Insertion Loss	VSWR	Power (Watts) (peak/avg)
T-100S01	0.15 - 0.175	18	0.7	1.3:1	1000 / 100
T-300S03	0.7 - 1.0	17	0.5	1.35:1	1000 / 100
T601S01	1.0 - 2.0	17	0.6	1.35:1	200 / 20
T602S01	2.0 - 4.0	20	0.5	1.25:1	100 / 2
T603S02	3.0 - 6.0	18	0.5	1.25:1	100 / 10
T-604S20	4.0 - 8.0	18	0.5	1.3:1	100 / 10
T-204S01	4.7 - 6.0	23	0.25	1.15:1	100 / 10
T-605S10	5.0 - 10.0	18	0.5	1.3:1	20 / 2
T-105S07	5.8 - 6.5	25	0.25	1.15:1	100 / 10
T-606S01	6.0 - 12.0	18	0.4	1.25:1	20 / 2
T1006S01	6.0 - 18.0	13	1.0	1.6:1	15 / 2
T-107S10	7.0 - 8.5	25	0.25	1.15:1	200 / 20
T-407S02	7.0 - 11.0	25	0.4	1.15:1	20 / 10
T-608S03	8.0 - 16.0	20	0.5	1.25:1	50 / 5
T-808S01	8.0 - 20.0	15	1.0	1.45:1	10 / 1
T-109S15	9.2 - 10.5	23	0.3	1.22:1	200 / 20
T-610S01	10.0 - 20.0	17	0.7	1.35:1	10 / 1
T-412S01	12.0 - 18.0	20	0.5	1.25:1	10 / 1
T-613S01	13.0 - 26.5	15	0.8	1.5:1	20 / 0.5
T-013S10	13.5 - 14.5	23	0.3	1.22:1	10 / 2
T-014S15	14.5 - 15.5	23	0.3	1.22:1	10 / 1
T-115S06	15.0 - 18.0	22	0.4	1.22:1	2 / 0.5
T-318S01	18.0 - 26.5	18	0.5	1.25:1	2 / 0.5
T-126K01	26.0 - 30.0	17	0.8	1.4:1	2 / 0.5
T-426K02	26.5 - 40.0	15	1.2	1.5:1	2 / 0.5

### Drop-In Isolators

Model Number	Freq. Range (GHz)	Isolation dB	Insertion Loss	VSWR	Power (Watts) (peak/avg)
DNF2540T0020	0.79 - 0.86	18	0.5	1.30:1	300
DNF2540T0100	1.2 - 1.4	20	0.4	1.25:1	300
DNF1900T00220	2.1 - 2.4	20	0.5	1.25:1	200
DNF1900-T0245	2.7 - 3.1	20	0.5	1.25:1	200 / 20
DNF1900-T0315	3.6 - 4.2	23	0.4	1.16:1	100 / 10
SMF950-F0400	4.2 - 4.4	20	0.5	1.25:1	50 / 5
DNF1300-T0410	4.4 - 5.0	20	0.4	1.25:1	100 / 10
DNF1300-T0500	5.0 - 6.0	20	0.4	1.25:1	100 / 10
SMF1150-F0610	6.0 - 18.0	13	1.3	1.7:1	3 / 0.5
DNF1300-T0600	6.4 - 7.8	20	0.5	1.25:1	50 / 5
SMF950-F0710	7.0 - 11.0	18	0.5	1.33:1	5 / 0.5
DNF1300-T0720	7.8 - 8.5	23	0.4	1.15:1	50 / 5
SMF950-F0810	8.0 - 12.0	18	0.5	1.25:1	5 / 0.5
SMF1150-F0800	8.0 - 18.0	16	0.8	1.4:1	5 / 0.5
SMF950-F1010	10.0 - 15.0	17	0.5	1.25:1	10 / 2
SMF635-F1210	12.0 - 18.0	17	0.7	1.35:1	5 / 0.5
SMF635-F1320	13.0 - 15.5	20	0.5	1.25:1	10 / 1
SMF635-F1415	14.0 - 14.5	20	0.4	1.25:1	10 / 1
SMF635-F1510	15.0 - 18.0	20	0.6	1.25:1	10 / 1
SMF635-F1800	18.0 - 21.0	20	0.4	1.3:1	5 / 0.5
SMF635-F2103	21.2 - 23.6	18	0.7	1.3:1	5 / 0.5

### Surface-Mount Isolators

Model Number	Freq. Range (GHz)	Isolation dB	Insertion Loss	VSWR	Forward Power (Watts)
SMD1900-T0204	2.9 - 3.7	20	0.7	1.20:1	5
SMD1300-T0390	3.6 - 4.2	20	0.5	1.25:1	5
SMD1300-T0470	4.4 - 5.0	20	0.5	1.25:1	5
SMD1300-T0501	5.6 - 7.1	20	0.5	1.25:1	5
SMD1300-T0700	7.1 - 8.5	20	0.5	1.25:1	5
SMD1300-T0800	8.0 - 12.0	20	0.5	1.25:1	3.2
SMD890-F1501	15.0 - 18.0	20	0.8	1.25:1	5
SMD635-T2400	21.6 - 26.4	17	1	1.35:1	2
SMD635-T3300	33.4 - 36.0	17	1	1.35:1	2

## Mixers

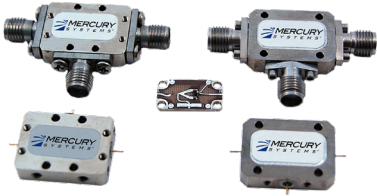

With reliability built-in to handle the harshest environments, our family of mixers has again and again proven itself in platforms operating from ground, to air, to space. The broad product portfolio uses architectures such as double or triple balanced and a design approach that can be manufactured at the space-qualified level.

Model Number	Freq. Range (GHz)	Type	LO Power (dBm) typ.	Conversion Loss (dB) typ./max	IF Frequency (GHz)	LO to RF Isolation (dBm) min/typ.	LO to IF Isolation (dBm) min/typ.	IP3 IN typ.	P1dB IN typ.
MXT313	DC - 3.4	Termination Insensitive	13	7	0.01 - 2.0	40	42	21	10
B21Q	2.0 - 8.0	Tripled Balanced	19	6.2	0.01 - 4.0	26	28	21	13
B22K	2.0 - 8.0	Tripled Balanced	10	6.2	2.0 - 6.0	24	28	14	4
B24V	2.0 - 12.0	Double Balanced	16	5.7	DC - 1.5	38	35	19	10
U20H	2.0 - 18.0	Double Balanced	7	7.3	DC - 2	27	22	11	1
U22K	2.0 - 18.0	Tripled Balanced	19	6.8	1.5 - 8.0	28	28	21	13
B30H	3.0 - 7.0	Double Balanced	7	5.5	DC - 2.0	38	35	11	1
MIQ30V	3.0 - 6.0	IQ Mixers	17	5.5	DC - 0.5	31	31	21	12
B50A	5.0 - 18.0	Double Balanced	13	6.2	DC - 4.0	35	30	17	7
MIQ50A	5.6 - 9.0	IQ Mixers	13	5	DC - 0.5	31	31	17	8
B61A	6.0 - 18.0	Tripled Balanced	13	7	1.5 - 8.0	28	26	17	7
B61Q	6.0 - 18.0	Tripled Balanced	19	7	1.5 - 8.0	28	26	21	13
MIQ80V	8.0 - 13.0	IQ Mixers	17	5	DC - 0.5	31	31	21	12
B90V	9.0 - 16.0	Double Balanced	16	5.5	DC - 3.0	35	35	19	10

## x2 Multipliers

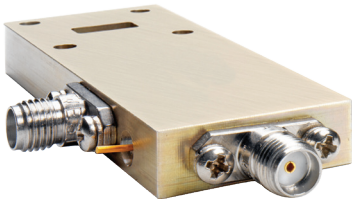

Our family of frequency multipliers are optimized to hold phase noise to a minimum—within 1dB of the theoretical limit. Standard products have been designed to balance phase noise, bandwidth and gain; however, the experienced design team is ready to customize any multiplier for your exact requirements.

- 4 to 110 GHz output frequency capability
- Multiplication factors from X2 to X80
- Broadband models: octave plus bandwidth
- Narrowband models: 5 to 20% bandwidth
- Popular output bands (GHz): 18-26.5, 26-40, 40-60

	Input Frequency (GHz)	Output Frequency (GHz)	Input Power (dBm)	Output Power (dBm)	Harmonics (dBc)	DC Supply
Doubler (Active)	10-20	20-40	10	10	-20	12V, 240mA
Tripler (Passive)	4.5-5	13.5-15	15	1	-20	0V, 0mA
Quadrupler (Active)	6.6-10	26-40	10	15	-15	12V, 410mA

## Voltage Controlled Oscillators

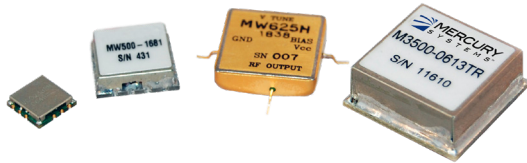

Our VCOs (Voltage Controlled Oscillators) offer predictable consistency, rugged design and reliable performance. Our VCO products will meet your application's most demanding stability and low phase noise requirements; featuring wide tuning bandwidth up to an octave. With custom designs and space qualified versions, trust Mercury to provide the VCOs for your next design.

Model Number	Frequency (MHz)	Tuning Voltage (V)	Power Output (dBm)	Phase Noise (dBc/Hz) typ.	Frequency Pushing (MHz/V) typ.	Frequency Pulling (MHz)	Harmonic Suppression (dBc)
MW500-1596	800 – 1600	0.5/5 V	6 +/-3	10 kHz offset -93 100 kHz offset -115	20	35	-8
MW500-1204	1600 - 3200	0.5/18 V	7 +/-2	10 kHz offset -96 100 kHz offset -119	2	18	-15
MW500-1674F	1710 – 2500	0.5/10 V	6.5 +/-3	10 kHz offset -87, 100 kHz offset -112	4	25	-10
MW500-1222	2000 – 4000	0.5/20 V	3 +/-3	10 kHz offset -82 100 kHz offset -104	6	30	-18
MW500-1672F	2400 – 4500	0.5/18 V	6.5 +/-3.5	10 kHz offset -78 100 kHz offset -100	10	25	-10
MW500-1408	3070 – 3340	0.5/4.5 V	5 +/-3	10 kHz offset -92 100 kHz offset -112	10	20	-15
MW500-1673F	3100 – 3340	0.5/10 V	6 +/-3.5	10 kHz offset -93 100 kHz offset -115	5	18	-12
MW500-1264	4000 – 6000	0.5/20 V	4 +/-4	10 kHz offset -80 100 kHz offset -104	10	65	-25
MW500-1164	4300 – 6400	0.5/18 V	4 +/-2	10 kHz offset -75 100 kHz offset -95	10	45	-15
MW500-1675F	4400 – 5850	0.5/10 V	3.5 +/-3	10 kHz offset -80 100 kHz offset -102	10	20	-10

## High-Power, Surface-Mount Limiters



Our portfolio of high-power surface mount RF limiters are precision engineered to deliver uncompromising performance for SWaP-sensitive applications demanding full functionality in the harshest of operating environments. Unique PIN diode architecture minimizes junction temperatures to assure long life under high-power conditions. By replacing cable interconnects with surface mount technology, physical footprint reductions are enabled without sacrificing performance or reliability.

	Freq Range (GHz)	Max Pulse Width (µSec)	Peak Power (W)	Flat Leakage (dBm)	Dimensions
EL0389	8.5-12	5	200	17	4mm x 3mm

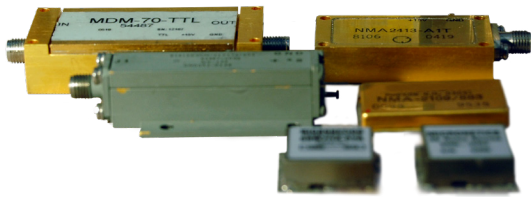

From noise modules used in monitoring receiver components to our specialized noise modules for Bit Error Rate (BER) testing and dithering circuits – Nobody understands noise better.

## Broadband Coaxial Noise Sources

Model Number	Freq. Range (GHz)	Output (dB min ENR)	Spectral Density (dBm/Hz)	Peak Factor	Bias Voltage (V)
NSL2-B	0.001 – 1.0	29.0 – 31.0	-144	5:01	15
NST04-B	0.01 – 4.0	25	-149	5:01	15
NST26-A	0.1 – 27.0	24	-150	5:01	28
NS5101-A1W	0.5 – 4.0	25	-149	5:01	15
NS5102-A2X	1.0 – 18.0	25	-149	5:01	15

## Fullband Coaxial Noise Sources

Model Number	Freq. Range (GHz)	Output (dB min ENR)	Spectral Density (dBm/Hz)	Noise Power (N) (dBm)	Flatness (dB P-P) max	Bias Voltage (V)
RFN55S	2.0 – 4.0	55	-119	5:01	28 or 15	200
RFN25C	4.0 – 8.0	25	-144	5:01	28 or 15	20
NS2640	26.5 - 40.0	14.0 - 20.0	-157	5:01	28 or 15	200

## Surface-Mount Noise Sources

Model Number	Freq. Range	Output (dB min ENR)	Spectral Density (dBm/Hz)	Flatness (dB P-P) max	Peak Factor	Bias Voltage (V)
SMN7105-D1C	100 kHz – 3 MHz	101	-73	2	5:01	12
NC504SM-12	200 kHz – 3.5 GHz	31	-143	2	5:01	12
SMN3018-D1D	20 MHz – 6 GHz	30	-148	3	5:01	12

## High-Power Noise Sources

Model Number	Freq. Range (GHz)	Output (dB min ENR)	Spectral Density (dBm/Hz)	Noise Power (N) (dBm)	Flatness (dB P-P) max	Bias Voltage (V)
NMA-5108	100Hz – 300MHz	97.5 to 104.0	-75	10	3	28
NMA-2513	0.01 – 4.0	78	-96	0	4	5 and 12
NMA-5300	2.0 - 18.0	64.5 to 72.0	-107	-5	5	15

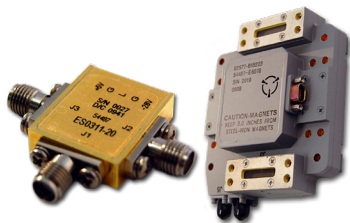

Mercury Systems' PIN diode switch family spans the frequency range of 0.5 to 40 GHz. They offer both high performance and integrated high speed driver controlled TTL or CMOS signals in a compact package. These switches will maintain high performance as a drop-in device for system or subsystem requirements and are proven in critical applications.

### High-Speed Switches

Pin Diode Switch	Type	Freq. Range (GHz)	Isolation Loss (dB max)	VSWR (max)	Isolation (max)	Switching Speed
SP1T PIN Diode Switch	Reflective	0.5-18 GHz (band selective)	1.4 to 2.8	1.6 to 2.0	80 to 60	100
SP1T PIN Diode Switch	Absorptive	0.5-18 GHz (band selective)	1.5 to 3.0	1.6 to 2.0	80 to 65	100
SP2T PIN Diode Switch	Reflective	0.5-18 GHz (band selective)	1.4 to 3.0	1.6 to 2.0	80 to 60	100
SP2T PIN Diode Switch	Absorptive	0.5-18 GHz (band selective)	1.5 to 3.2	1.6 to 2.0	80 to 65	100
SP2T High Speed Switch	Reflective	18 – 40 GHz	2.5 to 3.0	2.0 to 2.5	30 to 35	100 to 500
SP3T PIN Diode Switch	Reflective	0.5-18 GHz (band selective)	1.5 to 3.2	1.6 to 2.0	80 to 60	100
SP3T PIN Diode Switch	Absorptive	0.5-18 GHz (band selective)	1.6 to 3.4	1.6 to 2.0	80 to 65	100
SP4T PIN Diode Switch	Reflective	0.5-18 GHz (band selective)	1.6 to 3.4	1.6 to 2.0	80 to 60	100
SP4T PIN Diode Switch	Absorptive	0.5-18 GHz (band selective)	1.7 to 3.6	1.6 to 2.0	80 to 65	100

### High-Power SPDT Switches

Model Number	Freq. Range (GHz)	Peak Power (Watts) (max)	Average Power (Watts) (max)	Pulse Width (uSec) (max)	Load VSWR (max)	Switching Speed (ns) (max)
ES0011	2.0 – 4.0	300	40	10	2:01	700
ES0012	4.0 – 8.0	300	40	10	2.5:1	200
ES0013	8.0 – 18.0	300	40	10	2.5:1	300
ES0309-20	0.1 – 1.0	30	30	CW	2:01	250
ES0309-5	0.1 – 1.0	5	5	CW	2:01	100
ES0313-20	0.5 – 4.0	20	20	CW	2:01	250
ES0313-5	0.5 – 4.0	5	5	CW	2:01	200
ES0313-50	0.5 – 4.0	50	50	CW	2:01	300
ES0314-20	2.0 – 8.0	20	20	CW	2:01	200
ES0314-5	2.0 – 18.0	5	5	CW	2:01	150

### Low-Power Switches

Model Number	Type	Freq. Range (GHz)	Isolation Loss (dB max)	VSWR (max)	Isolation (max)	Switching Speed
2S3020 Series	SPDT	2.0 – 18.0	1.5 to 2.4	1.7 to 2.0	60 to 55	50 ns
4S3060 Series	SP4T	2.0 – 18.0	1.5 to 2.9	1.8 to 2.0	60 to 55	50 ns
8S3223 Series w/SMA removable connectors	SP8T	2.0 – 18.0	3.5	2	60	100 ns

## Trusted Manufacturing Capabilities

- Multiple advanced manufacturing centers across the US
- Automated assembly capability, including
  - Integrated epoxy dispense / pick-and-place automation
  - Automatic wire bonders
  - Automated SMT assembly
- Automated test setups up to 110GHz
- On-site environmental screening
- Cybersecurity program based on NIST 800-171
- AS9100, ISO9001, ISO10012, and DMEA Certified
- James S. Cogswell Award

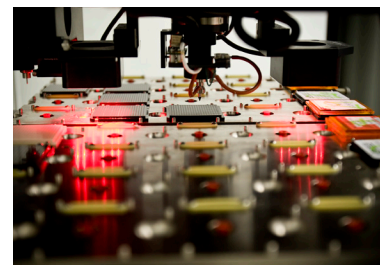
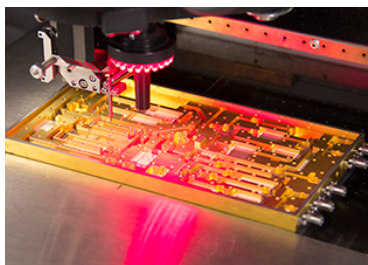

For more information contact Mercury Systems at [RF.Microwave@mrcy.com](mailto:RF.Microwave@mrcy.com) or see [www.mrcy.com/rf](http://www.mrcy.com/rf) for a detailed listing of RF and Microwave products

The Mercury Systems logo and the following are trademarks or registered trademarks of Mercury Systems, Inc.: Mercury Systems, Innovation That Matters. Other marks used herein may be trademarks or registered trademarks of their respective holders. Mercury believes this information is accurate as of its publication date and is not responsible for any inadvertent errors. The information contained herein is subject to change without notice.

Copyright © 2019 Mercury Systems, Inc.

3168.04E-0419-br-rf



### CORPORATE HEADQUARTERS

50 Minuteman Road • Andover, MA 01810 USA  
(978) 967-1401 • (866) 627-6951 • Fax (978) 256-3599

*Innovation That Matters®*



### HUDSON, NH

267 Lowell Road  
Hudson, NH 03051  
(603) 883-2900

### PHOENIX, AZ

3601 East University Drive  
Phoenix, AZ 85034  
(602) 437-1520

### CAMARILLO, CA

1000 Avenida Acaso  
Camarillo, CA 93012  
(805) 388-1345

### OXNARD, CA

300 Del Norte Blvd.  
Oxnard, CA 93030  
(805) 751-1100

### WEST CALDWELL, NJ

2 Henderson Drive, Suite B  
West Caldwell, NJ 07006  
(973) 244-1040

### SAN JOSE, CA

85 Nicholson Lane  
San Jose, CA 95134  
(669) 226-5800

### HUNTSVILLE, AL

555 Discovery Drive  
Huntsville, AL 35806  
(256) 721-1911