

AM6013 – Switch, Reflective

DC to 20 GHz SP4T



Description

AM6013 is a Single-Pole 4-Throw (SP4T) switch covering the DC to 20 GHz frequency range. The positive control device exhibits low insertion loss, flat frequency response, and high isolation over the operating temperature range of -40C to +85C.



Features

- 1.3 dB Insertion Loss
- +42 dBm Input IP3
- +3.3V to +5V Supply
- +3.3V to +5V Control
- >30 dB Isolation
- 3mm QFN
- -40C to +85C Operation

Functional Diagram

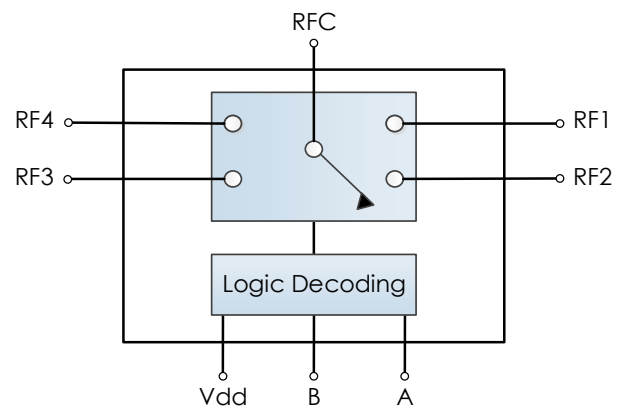

Characteristic Performance

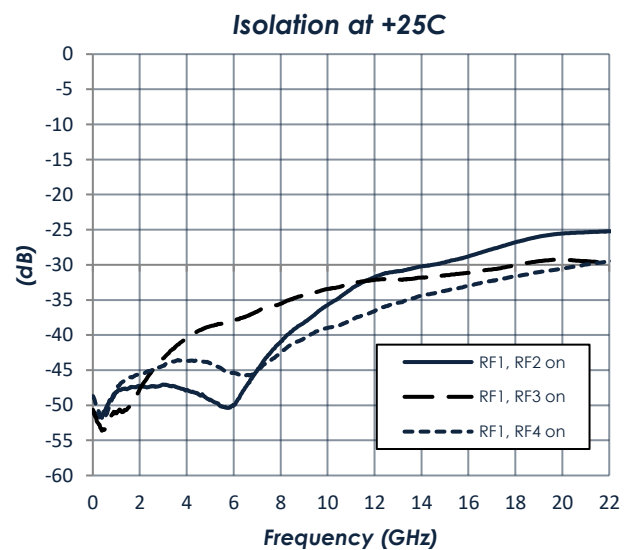
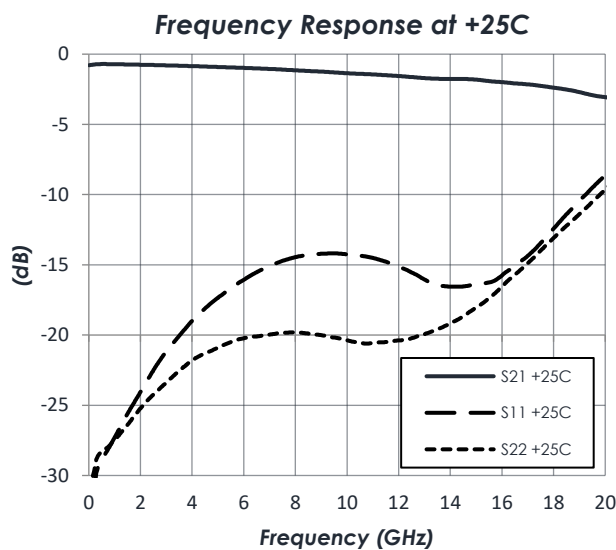

Table of Contents

Description	1	DC Electrical Characteristics	5
Features	1	RF Performance	5
Functional Diagram	1	Timing Characteristics	5
Characteristic Performance	1	State Table	5
Revision History	2	Typical Performance	6
Pin Layout and Definitions	3	Typical Application	8
Specifications	4	3mm 16 Lead QFN Details	10
Absolute Maximum Ratings	4	Evaluation PC Board	11
Handling Information	4	Related Parts	11
Recommended Operating Conditions	4	Component Compliance Information	12

Revision History

Date	Revision Number	Notes
October 23, 2019	1	Initial Release

Pin Layout and Definitions

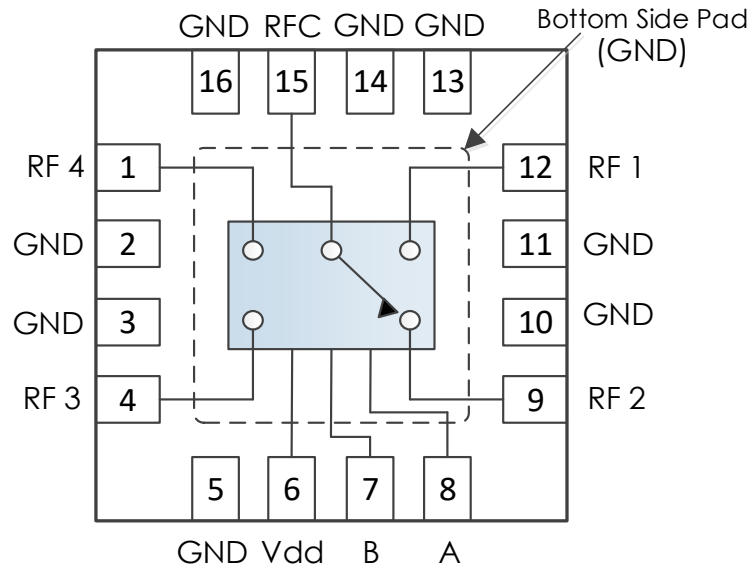

Pin Number	Pin Name	Pin Function
1	RF4	RF4 Output – 50 Ohms – DC Coupled. External DC blocking capacitors required*
2-3	GND	Ground – Common
4	RF3	RF3 Output – 50 Ohms – DC Coupled. External DC blocking capacitors required*
5	GND	Ground – Common
6	VDD	DC Power Input
7	B	Switch Control B
8	A	Switch Control A
9	RF2	RF2 Output – 50 Ohms – DC Coupled. External DC blocking capacitors required*
10-11	GND	Ground – Common
12	RF1	RF1 Output – 50 Ohms – DC Coupled. External DC blocking capacitors required*
13-14	GND	Ground – Common
15	RFC	RFC Input – 50 Ohms – DC Coupled. External DC blocking capacitors required*
16	GND	Ground – Common

***Note:** DC blocking caps not required if in series with other Atlanta Micro parts of the same reference voltage

AM6013 – Switch, Reflective

DC to 20 GHz SP4T



Specifications

Absolute Maximum Ratings

	Minimum	Maximum
Supply Voltage	-0.3 V	+6.0 V
RF Input Power		+27 dBm
Operating Junction Temperature	-40 C	+150 C
Storage Temperature Range	-50 C	+150 C

Note: Any device operation beyond the Absolute Maximum Ratings may result in permanent damage to the device. The values listed in this table are extremes and do not imply functional operation of the device at these or any other conditions beyond what is listed under Recommended Operating Conditions. Any part subjected to conditions outside of what is recommended for an extended amount of time may suffer from reliability concerns.

Handling Information

	Minimum	Maximum
Storage Temperature Range (Recommended)	-50 C	+125 C
Moisture Sensitivity Level	MSL 3	



Atlanta Micro products are electrostatic sensitive.
Follow safe handling practices to avoid damage

Recommended Operating Conditions

	Minimum	Typical	Maximum
Supply Voltage	+2.5 V	+5.0 V	
Operating Case Temperature	-40 C		+85 C
Operating Junction Temperature	-40 C		+125 C

AM6013 – Switch, Reflective

DC to 20 GHz SP4T

DC Electrical Characteristics

(T = 25 °C unless otherwise specified)

Parameter	Testing Conditions	Minimum	Typical	Maximum
DC Supply Voltage		+2.5 V	+5.0 V	
DC Supply Current	VDD = +3.3 V		6 mA	
	VDD = +5.0 V		7 mA	
Power Dissipated	VDD = +3.3 V		20 mW	
	VDD = +5.0 V		35 mW	
Logic Level Low		0.0 V		+0.5 V
Logic Level High		+2.0 V		+VDD

RF Performance

(T = 25 °C unless otherwise specified)

Parameter	Testing Conditions	Minimum	Typical	Maximum
Frequency Range		DC		20 GHz
Insertion Loss	f = 0.01 GHz		0.8 dB	
	f = 10 GHz		1.3 dB	
	f = 20 GHz		3 dB	
Return Loss	f = 0.01 GHz		30 dB	
	f = 10 GHz		14 dB	
	f = 20 GHz		9 dB	
Input IP3	VDD = +5.0 V		+42 dBm	

Timing Characteristics

Parameter	Minimum	Typical	Maximum
Switching Speed (Path Enabled to Disabled)		6 ns	
Switching Speed (Path Disabled to Enabled)		6 ns	

State Table

A	B	State
Low	Low	RF1 to RFC
Low	High	RF3 to RFC
High	Low	RF2 to RFC
High	High	RF4 to RFC

AM6013 – Switch, Reflective

DC to 20 GHz SP4T

Typical Performance

(VDD = +5.0 V. Data measured via probes outside IC package on 10 mil Rogers RO4350B™)

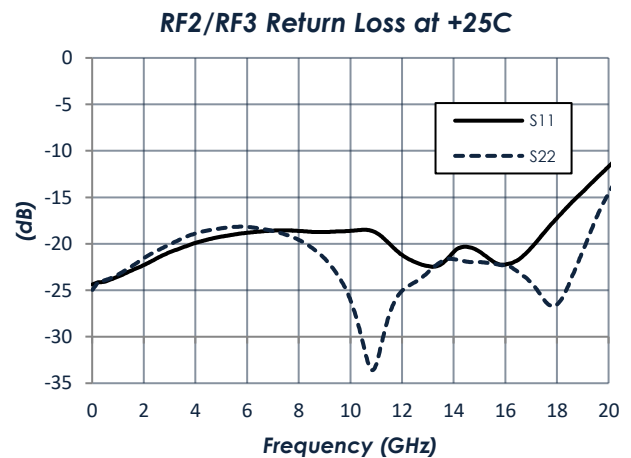
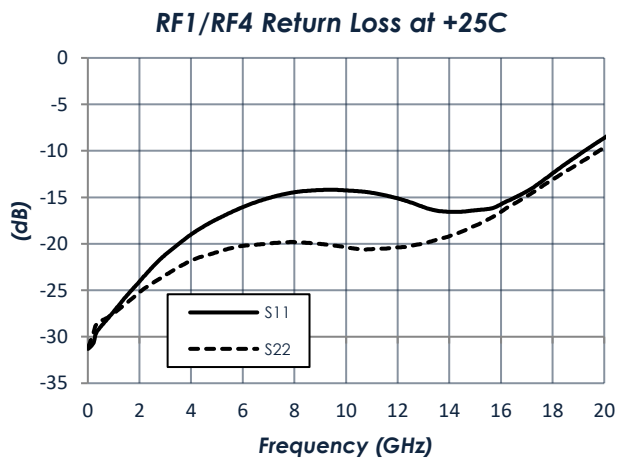
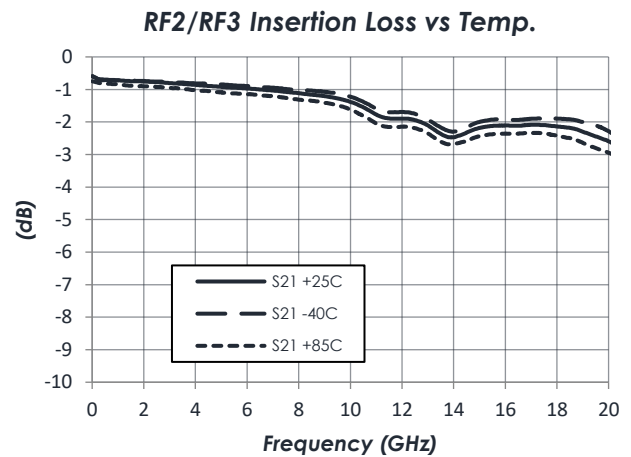
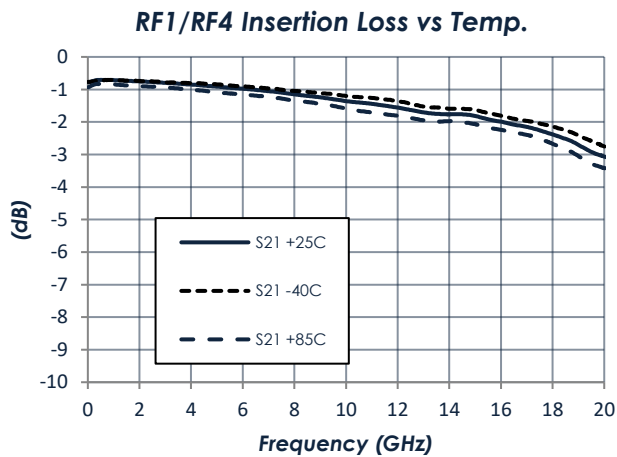
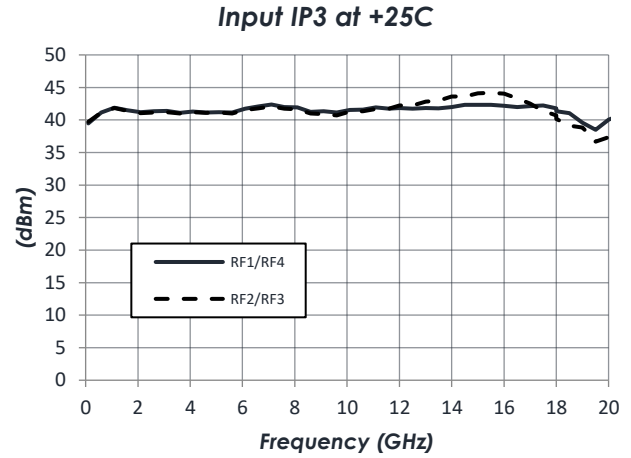
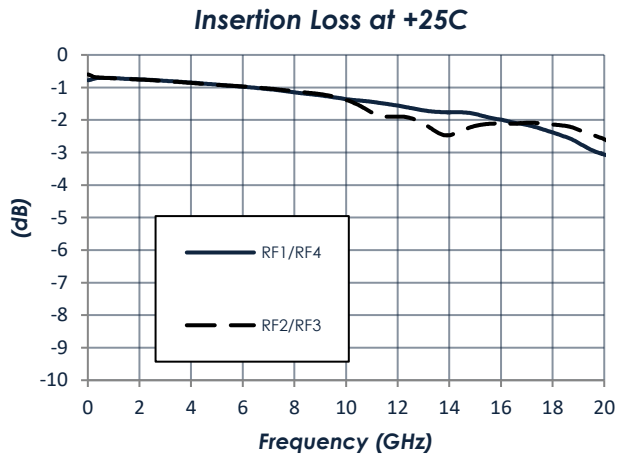

AM6013 – Switch, Reflective

DC to 20 GHz SP4T

Typical Performance (continued)

(VDD = +5.0 V. Data measured on 10 mil Rogers RO4350B™)

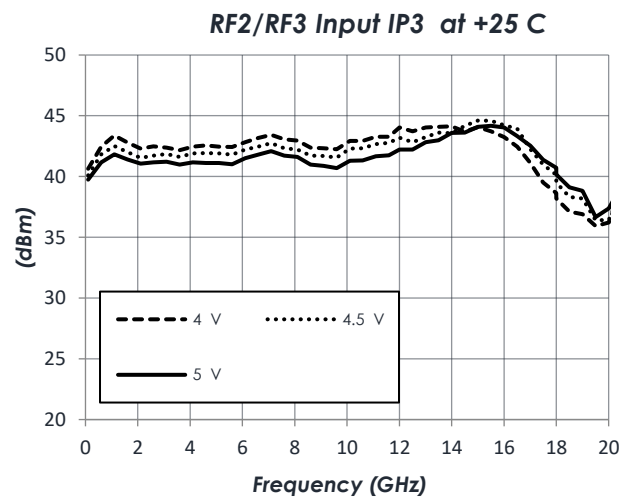
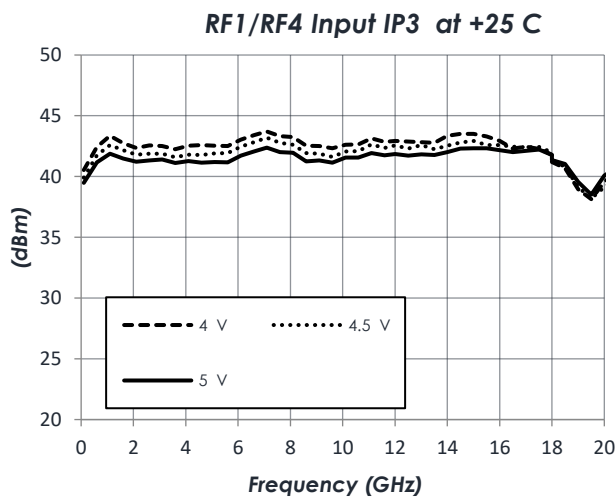
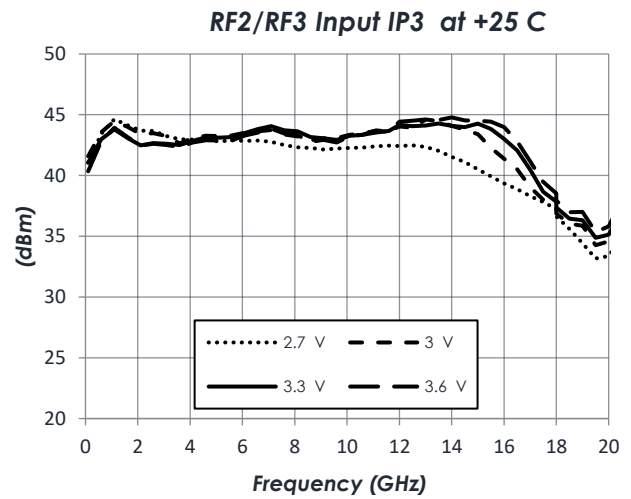
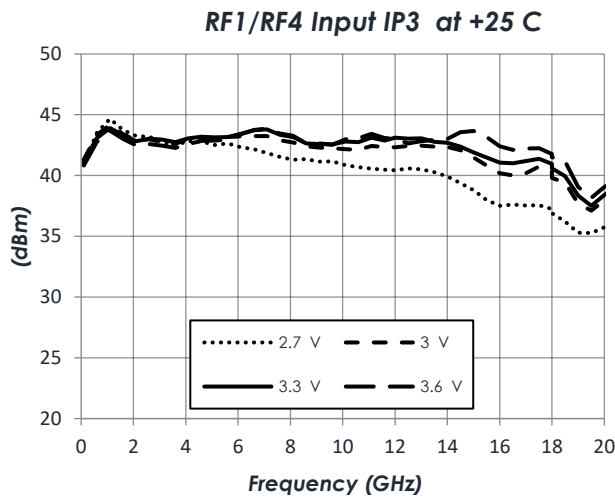
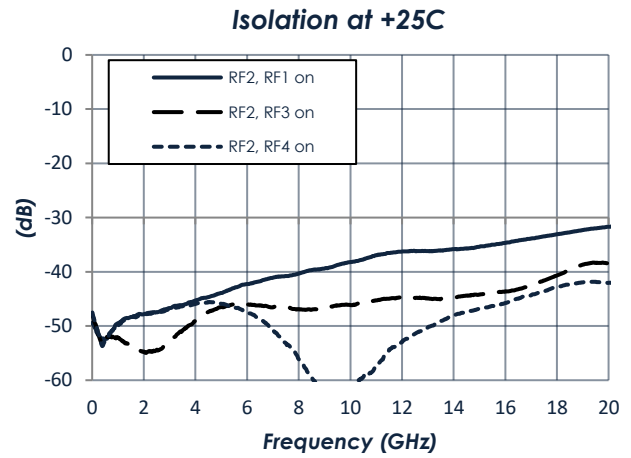
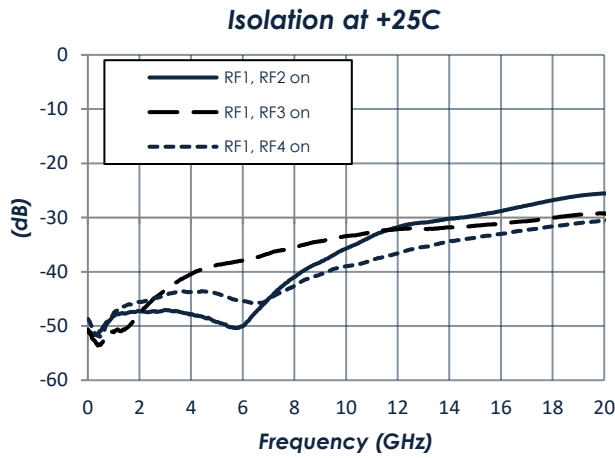

AM6013 – Switch, Reflective

DC to 20 GHz SP4T

Typical Performance (continued)

(VDD = +5.0 V, T = 25 C. Data measured on 10 mil Rogers RO4350B™)

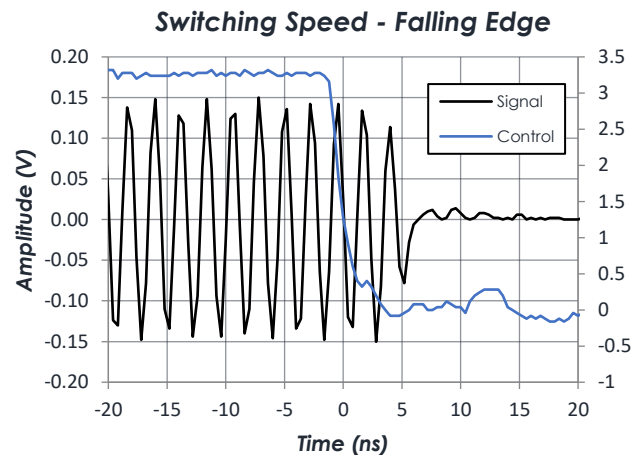
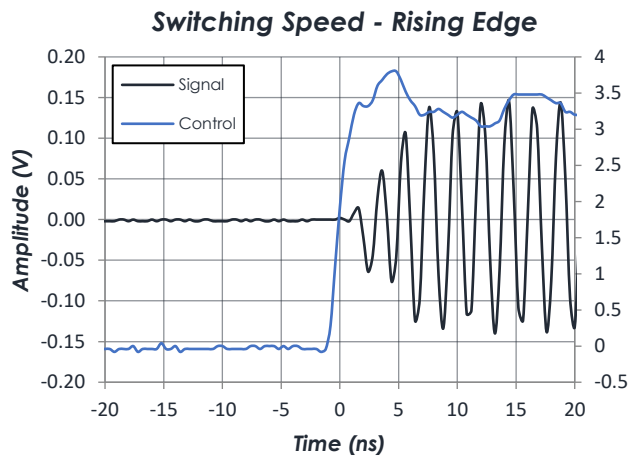

AM6013 – Switch, Reflective

DC to 20 GHz SP4T

Typical Application

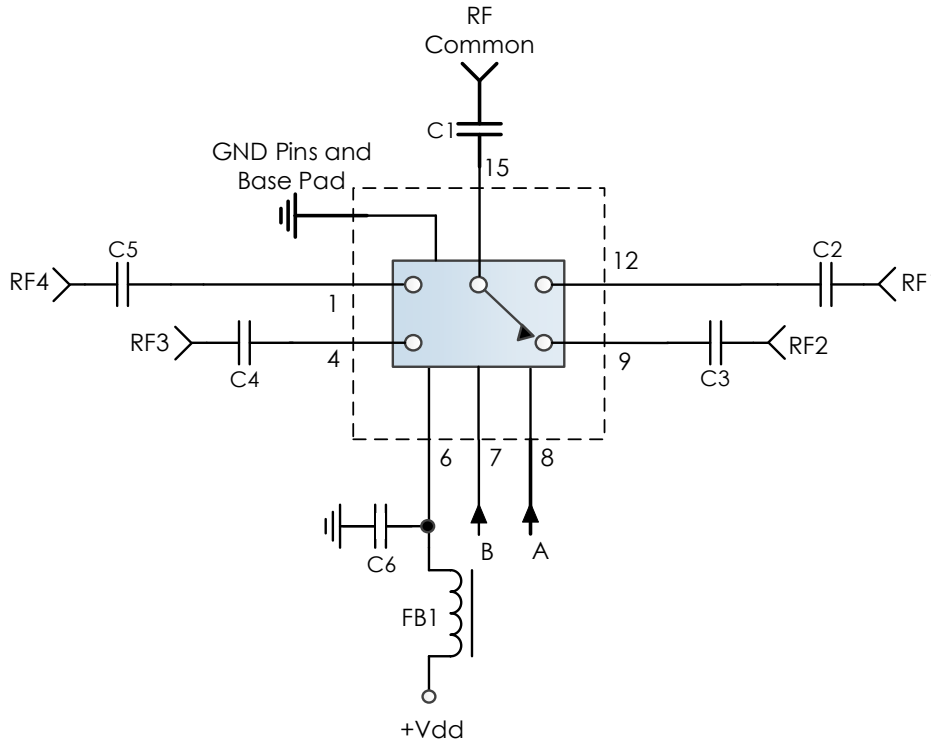

Recommended Component List (or equivalent):

Part	Value	Part Number	Manufacturer
C1-C5	0.1 μ F	0201BB104KW160	Passives Plus
C6	0.1 μ F	C1005X7R1H104K050BB	TDK
FB1	-	MMZ1005A222E	TDK

Notes:

1. DC blocking capacitors should be high performance, low-loss, broadband capacitors for optimal performance.
2. RC Filtering on the control line is recommended to prevent digital noise from coupling to the RF path.
 - a. Select control line RC filter values based on desired logic source decoupling and switching speed.

AM6013 – Switch, Reflective

DC to 20 GHz SP4T



3mm 16 Lead QFN Details

Package Drawing

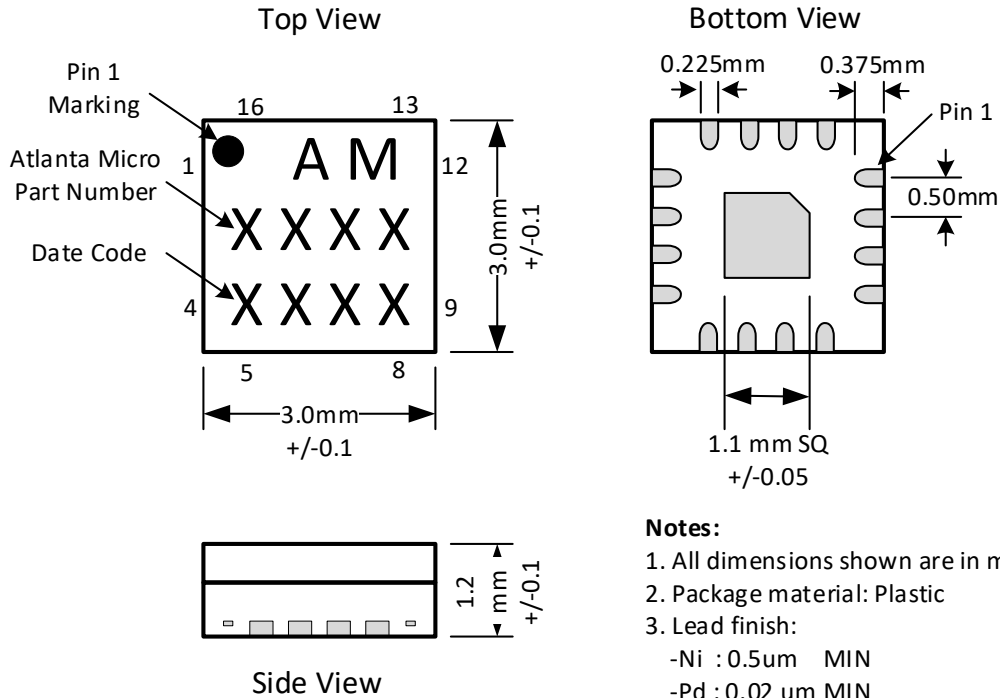

Notes:

1. All dimensions shown are in mm
2. Package material: Plastic
3. Lead finish:
 - Ni : 0.5um MIN
 - Pd : 0.02 um MIN
 - Au : 0.05 um MAX

Recommended Footprint

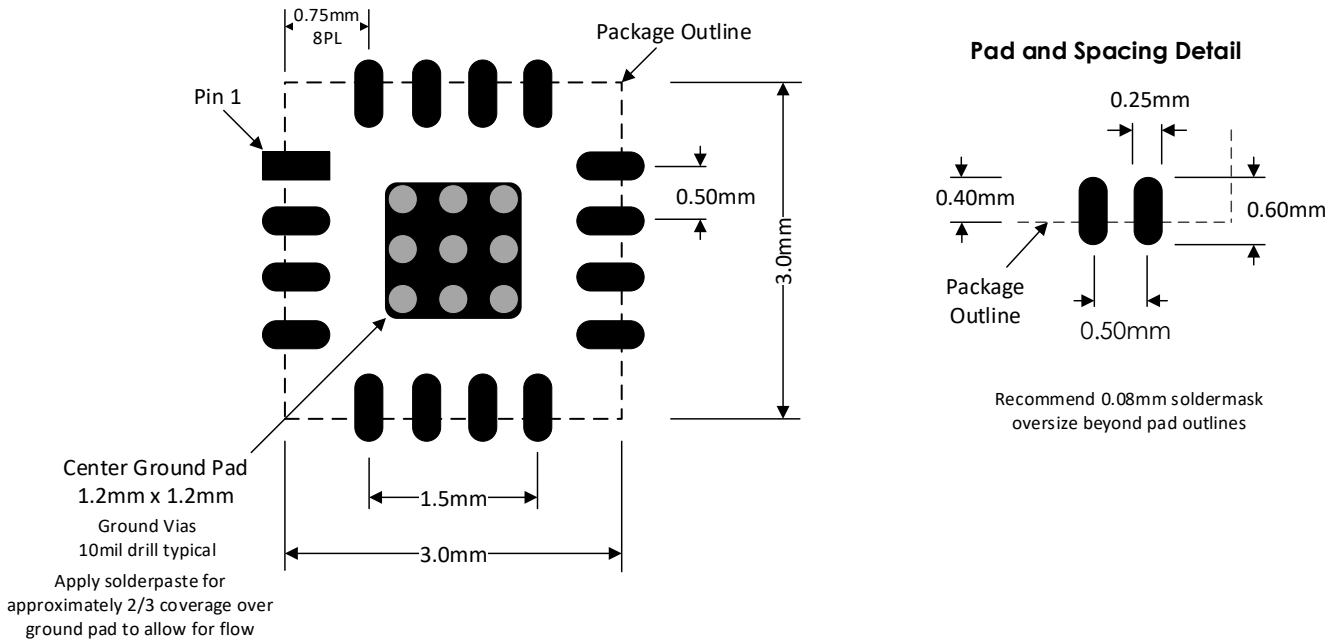

To obtain price, delivery, or to place an order contact sales@atlantamicro.com
Atlanta Micro Inc., 3720 Davinci Ct, Suite 125, Norcross, GA 30092 • Phone: (470) 253-7640 • www.atlantamicro.com

AM6013 – Switch, Reflective

DC to 20 GHz SP4T

Evaluation PC Board

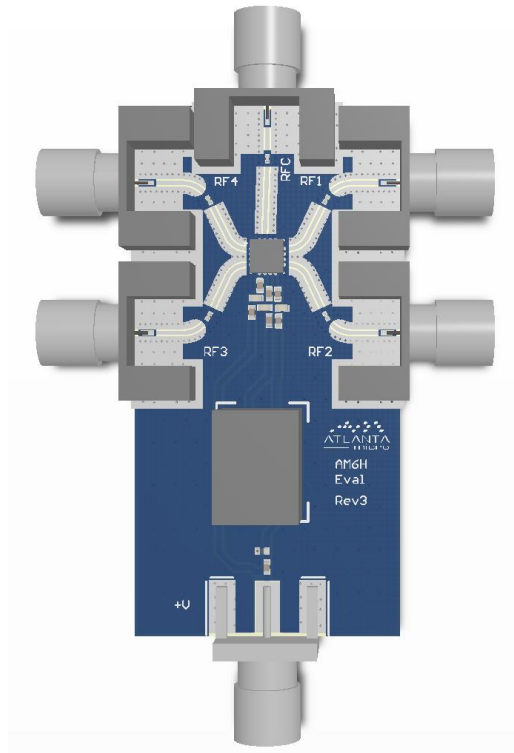

Related Parts

Part Number	Description
AM6011	DC to 10 GHz SP8T, Reflective
AM6012	DC to 18 GHz SPDT, Reflective
AM6015	DC to 18 GHz SP6T, Reflective
AM6016	DC to 26.5 GHz SPDT, Reflective
AM6029	DC to 18 GHz SP4T, Reflective
AM6031	DC to 20 GHz SPDT, Absorptive

Component Compliance Information

RoHS: Atlanta Micro, Inc. hereby certifies that all products comply with the EC Directive 2011/65/EC on the Restriction of Hazardous Substances, commonly known as EU-RoHS 6 and 10. All products supplied by Atlanta Micro shall be compliant with the European Directive 2011/65/EC based on the following substance list.

Substance List	Allowable Maximum Concentration
Lead (Pb)	<1000 PPM (0.1% by weight)
Mercury (Hg)	<1000 PPM (0.1% by weight)
Cadmium (Cd)	<75 PPM (0.0075% by weight)
Hexavalent Chromium (CrVI)	<1000 PPM (0.1% by weight)
Polybrominated Biphenyls (PBB)	<1000 PPM (0.1% by weight)
Polybrominated Diphenyl ethers (PBDE)	<1000 PPM (0.1% by weight)
Decabromodiphenyl Deca BDE	<1000 PPM (0.1% by weight)
Bis (2-ethylhexyl) Phthalate (DEHP)	<1000 PPM (0.1% by weight)
Butyl Benzyl Phthalate (BBP)	<1000 PPM (0.1% by weight)
Dibutyl Phthalate (DBP)	<1000 PPM (0.1% by weight)
Diisobutyl Phthalate (DIBP)	<1000 PPM (0.1% by weight)

REACH: Atlanta Micro, Inc. neither uses nor intentionally adds any of the substances considered to be a Substance of Very High Concern (SVHC) as defined by the EU Regulation (EC) No. 1907-2006 on Registration, Evaluation, Authorization, and Restriction of Chemicals (REACH).

Conflict Materials: Atlanta Micro does not knowingly use materials that are sourced from the Democratic Republic of Congo (DRC) or any other known conflict regions. Atlanta Micro's supply chain is comprised of sources that are both environmentally and socially responsible. We periodically review this requirement with our vendors to ensure continued compliance.

Atlanta Micro takes its responsibility as a global partner seriously and will use due diligence within our supply chain to ensure all standards are met to the best of our knowledge.